



SERIES: ACZ11 | **DESCRIPTION:** MECHANICAL INCREMENTAL ENCODER

ELECTRICAL SPECIFICATIONS

parameter	conditions/description	min	typ	max	units
output waveform	square wave				
output signals	A, B phase				
current consumption	10 mA				
output phase difference	T1, T2, T3, T4 ≥ 3.5 ms @ 60 rpm (see output waveform)				
supply voltage	5 V dc max.				
output resolution	12, 15, 20, 30 ppr				
switch rating	12 V dc, 50 mA (ACZ11BRXE models only)				
insulation resistance	300 V dc, 100 MΩ				
withstand voltage	300 V ac				

MECHANICAL SPECIFICATIONS

parameter	conditions/description	min	typ	max	units
shaft load	axial			8	kgf
rotational torque	with detent click without detent click	60 60	140 80	220 100	gf·cm gf·cm
push switch operational force	(ACZ11BRXE models only)	300		900	gf·cm
push switch life	(ACZ11BRXE models only)			50,000	cycles
rotational life				30,000	cycles

ENVIRONMENTAL SPECIFICATIONS

parameter	conditions/description	min	typ	max	units
operating temperature		-10		65	°C
storage temperature		-40		75	°C
humidity		85			% RH
vibration	0.75 mm max. travel for 2 hours	10		55	Hz

PART NUMBER KEY

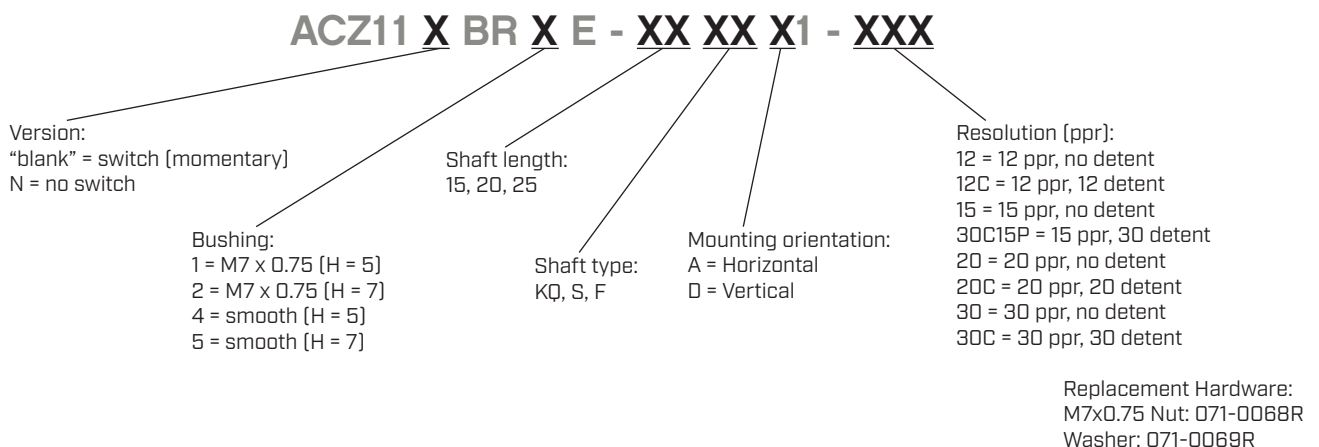

SHAFT OPTIONS (VERSIONS WITH SWITCH)

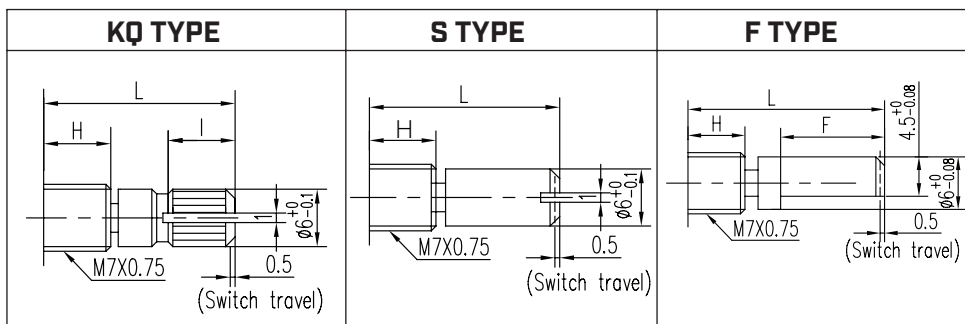

H=5

	15KQ	20KQ	25KQ
L	15	20	25
I	6	8.5	12

H=5

	15S	20S	25S
L	15	20	25

H=5

	15F	20F	25F
L	15	20	25
F	8	10	12

H=7

	15KQ	20KQ	25KQ
L	15	20	25
I	5	8.5	10

H=7

	15S	20S	25S
L	15	20	25

H=7

	15F	20F	25F
L	15	20	25
F	8	10	12

SHAFT OPTIONS (VERSIONS WITHOUT SWITCH)

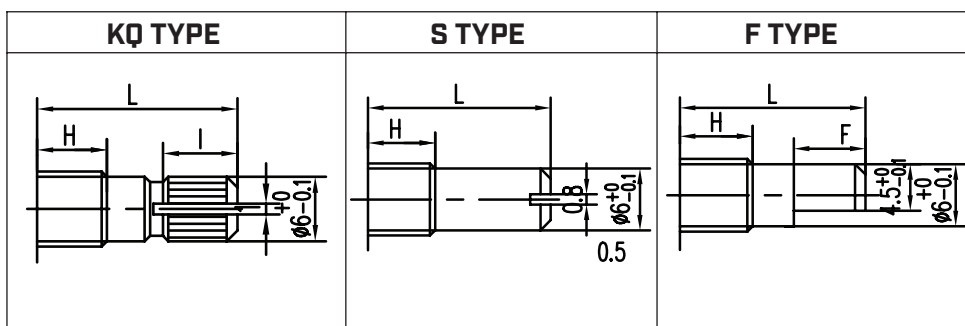

H=5

	15KQ	20KQ	25KQ
L	15	20	25
I	7	10	12

H=5

	15S	20S	25S
L	15	20	25

H=5

	15F	20F	25F
L	15	20	25
F	8	10	12

H=7

	15KQ	20KQ	25KQ
L	15	20	25
I	5	10	10

H=7

	15S	20S	25S
L	15	20	25

H=7

	15F	20F	25F
L	15	20	25
F	8	10	12

OUTPUT WAVEFORM



CW direction (@ 60 rpm)

DETENT POSITIONS

Model 12C & 20C

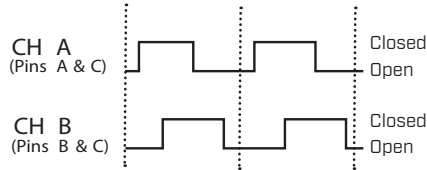

CW direction →

Model 15P30C

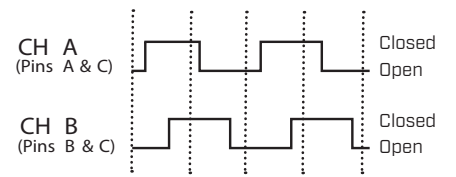

CW direction →

SLIDING NOISE

$t =$ Masking time to avoid chatter (5mS) $V_1 = V_2 = 1V$ max.



SUGGESTED FILTER



$R1, R2, R3, R4 = 10k\Omega$
 $C1, C2 = 0.01\mu F$

MECHANICAL DRAWING (HORIZONTAL)

units: mm
 tolerance:
 $X \leq 10$: ± 0.3 mm
 $10 < X \leq 30$: ± 0.5 mm
 Unless otherwise noted

ACZ11NBRXE

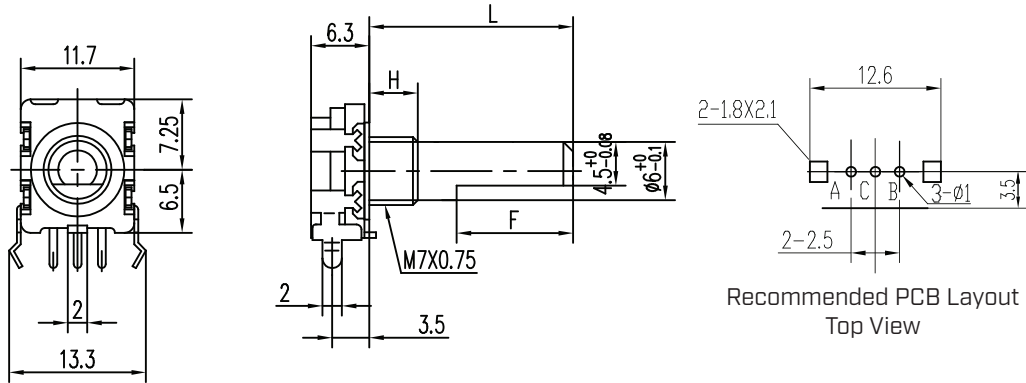

ACZ11BRXE

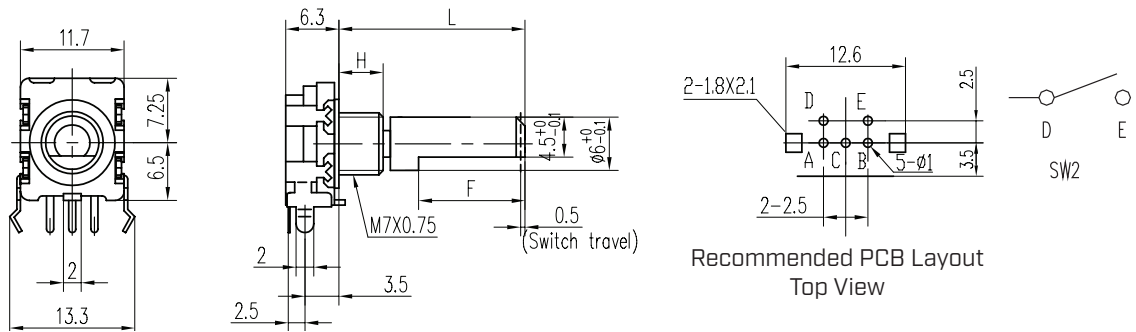

MECHANICAL DRAWING (VERTICAL)

units: mm
 tolerance:
 $X \leq 10$: ± 0.3 mm
 $10 < X \leq 30$: ± 0.5 mm
 Unless otherwise noted

ACZ11NBRXE

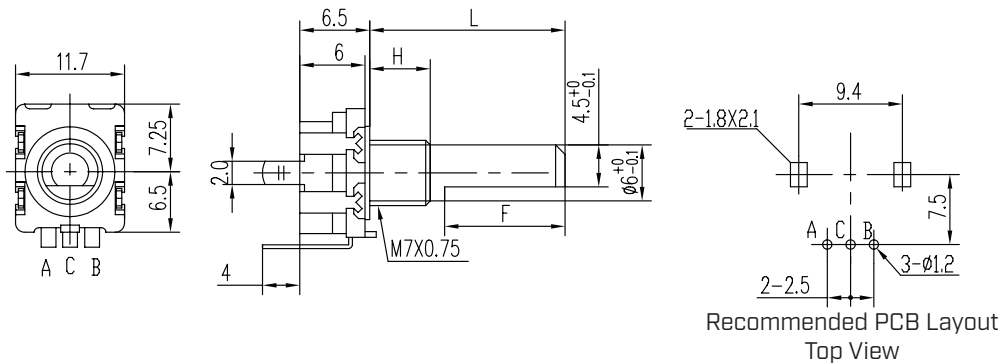

ACZ11BRXE

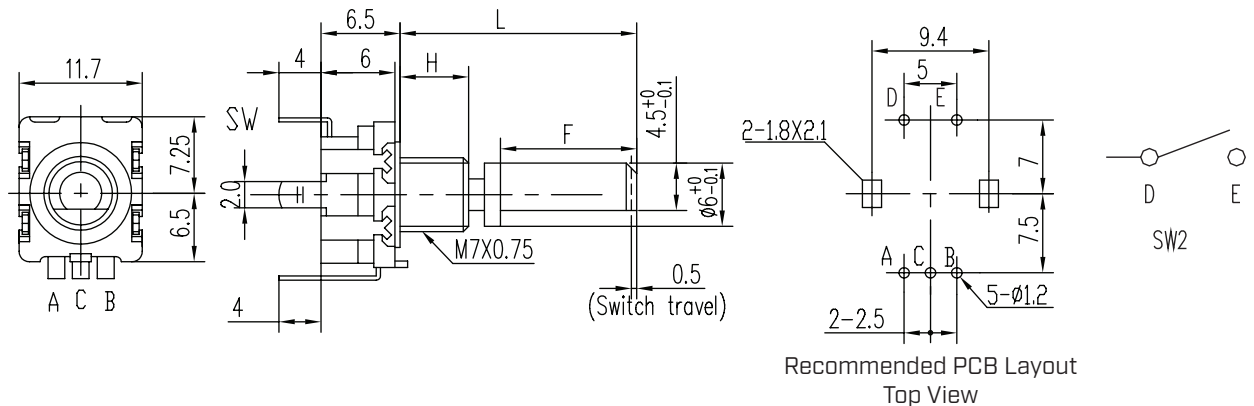

REVISION HISTORY

rev.	description	date
1.0	initial release	10/30/2009
1.01	brand update	10/04/2019
1.02	updated datasheet	06/15/2020
1.03	updated drawings; logo, datasheet style update	09/08/2022
1.04	CUI Devices rebranded to Same Sky	09/12/2024

The revision history provided is for informational purposes only and is believed to be accurate.



Same Sky offers a one (1) year limited warranty. Complete warranty information is listed on our website.

Same Sky reserves the right to make changes to the product at any time without notice. Information provided by Same Sky is believed to be accurate and reliable. However, no responsibility is assumed by Same Sky for its use, nor for any infringements of patents or other rights of third parties which may result from its use.

Same Sky products are not authorized or warranted for use as critical components in equipment that requires an extremely high level of reliability. A critical component is any component of a life support device or system whose failure to perform can be reasonably expected to cause the failure of the life support device or system, or to affect its safety or effectiveness.

[sameskydevices.com](https://www.sameskydevices.com)