

**MODEL:** CBLT-UA-P6-1 | **DESCRIPTION:** USB CABLE**FEATURES**

- USB 2.0
- type A male to DC plug 2.5 mm center
- 1 meter
- TPE jacket
- halogen free

**SPECIFICATIONS**

parameter	conditions/description	min	typ	max	units
rated voltage			20		Vdc
rated current				1	A
conductor resistance				5	Ω
insulation resistance	at 300 Vdc	10			M Ω
operating temperature		-20		80	$^{\circ}$ C
storage temperature		-20		80	$^{\circ}$ C
flammability rating	UL94V-0				
RoHS	yes				

MECHANICAL DRAWING

units: mm
 tolerance:
 X.X ±0.5 mm
 X.XX ±0.3 mm
 X.XXX ±0.1 mm
 unless otherwise noted

critical dimension: *

ITEM	DESCRIPTION	MATERIAL	PLATING/COLOR
1	cable	no UL OD: 3.5±0.15 mm TPE	black
2	connector 1	USB 2.0 Type A	insulator: white shell: nickel term.: gold flash
3	connector 2	5.5 x 2.5 barrel plug	nickel
4	over mold	TPE	black

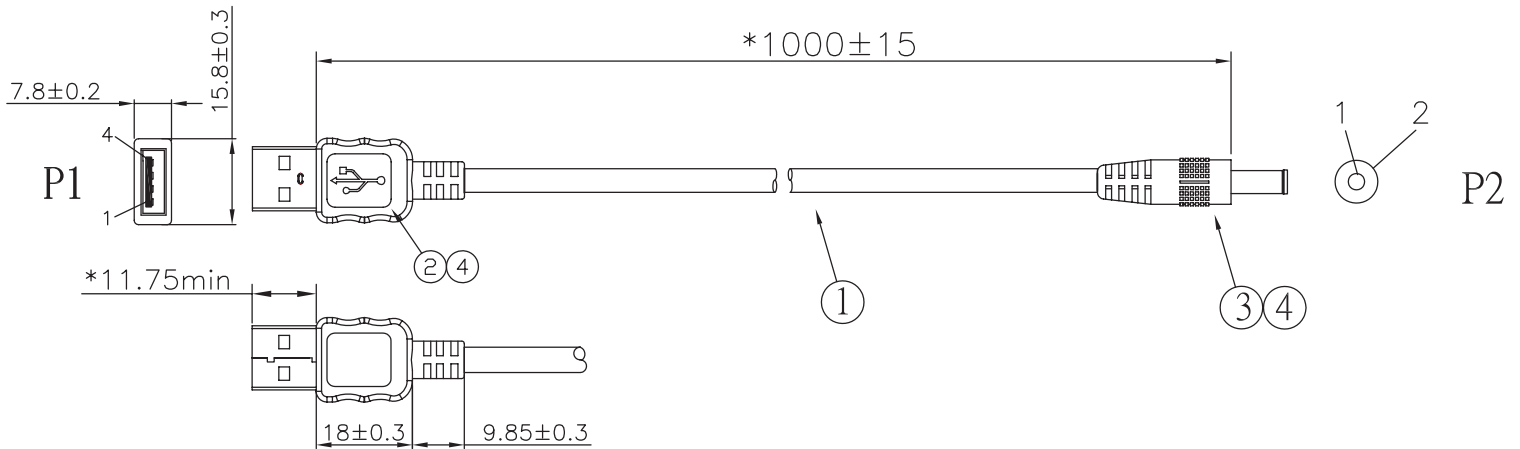

WIRE LIST

P1		P2	
1	—————	1	RED
4	—————	2	BLACK

PACKAGING

units: mm

Carton Size: 546 x 355 x 186 mm

Carton QTY: 100 pcs

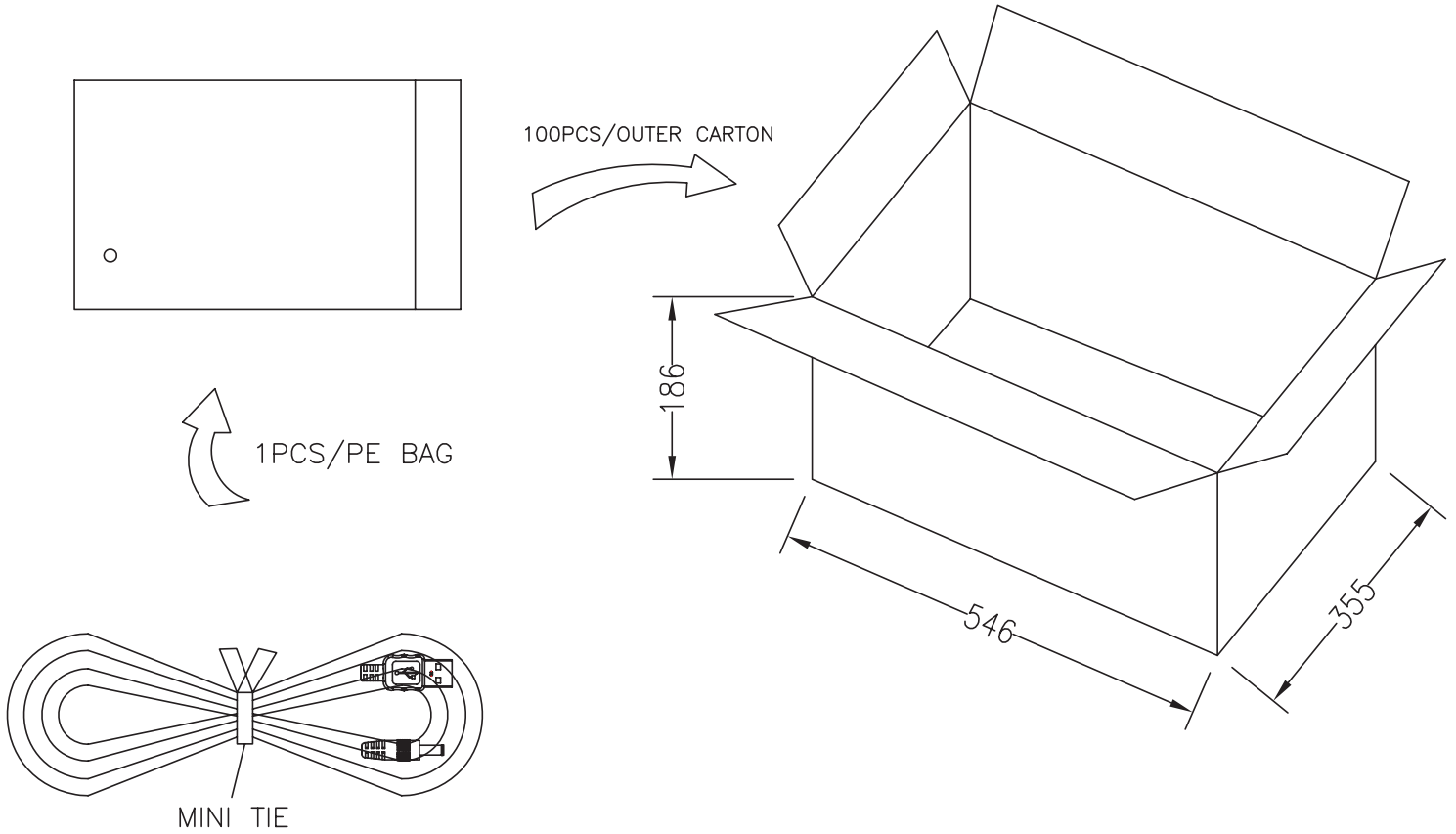

REVISION HISTORY

rev.	description	date
1.0	initial release	12/21/2018
1.01	brand update	02/17/2020
1.02	modified design, changed factory	01/27/2022
1.03	logo, datasheet style update	08/05/2022
1.04	CUI Devices rebranded to Same Sky	09/12/2024

The revision history provided is for informational purposes only and is believed to be accurate.



Same Sky offers a one (1) year limited warranty. Complete warranty information is listed on our website.

Same Sky reserves the right to make changes to the product at any time without notice. Information provided by Same Sky is believed to be accurate and reliable. However, no responsibility is assumed by Same Sky for its use, nor for any infringements of patents or other rights of third parties which may result from its use.

Same Sky products are not authorized or warranted for use as critical components in equipment that requires an extremely high level of reliability. A critical component is any component of a life support device or system whose failure to perform can be reasonably expected to cause the failure of the life support device or system, or to affect its safety or effectiveness.

[sameskydevices.com](https://www.sameskydevices.com)