

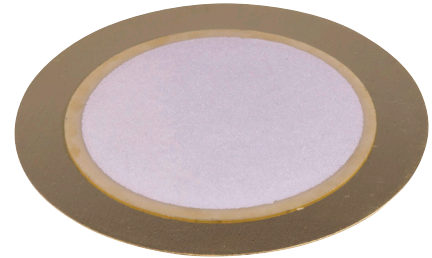

MODEL: CEB-2021 | **DESCRIPTION:** PIEZOELECTRIC DIAPHRAGM

FEATURES

- piezo element
- externally driven



SPECIFICATIONS

parameter	conditions/description	min	typ	max	units
operating voltage				30	Vp-p
resonant frequency		3,100	3,600	4,100	Hz
resonant impedance				300	Ω
electrostatic capacity	at 100 Hz	15,750	21,000	26,250	pF
dimensions	$\varnothing 20 \times 0.21$				mm
weight			0.4		g
material	brass				
operating temperature		-20		70	$^{\circ}\text{C}$
storage temperature		-30		80	$^{\circ}\text{C}$
hand soldering	brass silver	340 260	360 280	380 300	$^{\circ}\text{C}$ $^{\circ}\text{C}$
RoHS	yes				

MECHANICAL DRAWING

units: mm
tolerance: ± 0.5 mm

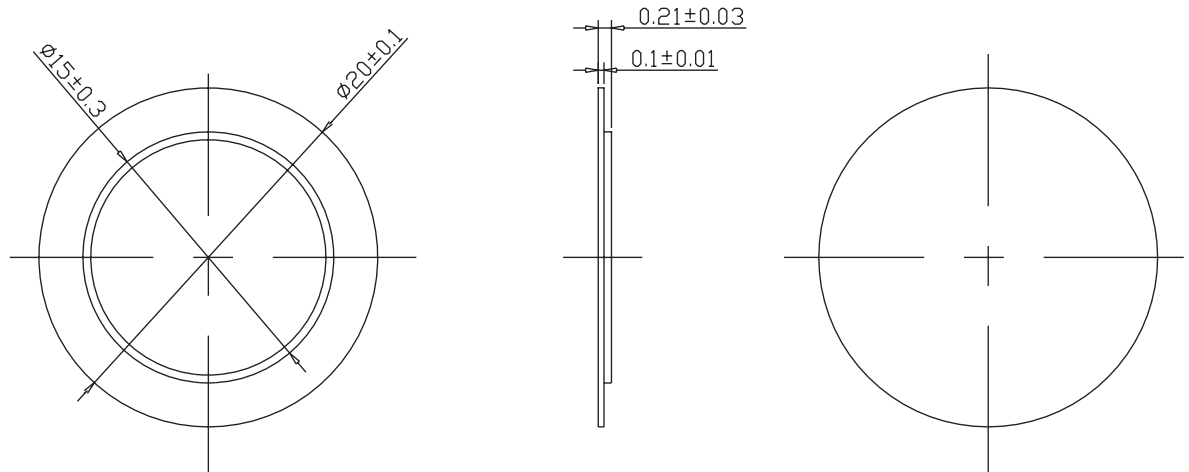

REVISION HISTORY

rev.	description	date
1.0	initial release	05/14/2024
1.01	CUI Devices rebranded to Same Sky	09/11/2024

The revision history provided is for informational purposes only and is believed to be accurate.



Same Sky offers a one (1) year limited warranty. Complete warranty information is listed on our website.

Same Sky reserves the right to make changes to the product at any time without notice. Information provided by Same Sky is believed to be accurate and reliable. However, no responsibility is assumed by Same Sky for its use, nor for any infringements of patents or other rights of third parties which may result from its use.

Same Sky products are not authorized or warranted for use as critical components in equipment that requires an extremely high level of reliability. A critical component is any component of a life support device or system whose failure to perform can be reasonably expected to cause the failure of the life support device or system, or to affect its safety or effectiveness.

[sameskydevices.com](https://www.sameskydevices.com)