



**MODEL:** CEB-27048 | **DESCRIPTION:** PIEZOELECTRIC DIAPHRAGM

**FEATURES**

- piezo element
- externally driven



**SPECIFICATIONS**

parameter	conditions/description	min	typ	max	units
operating voltage				30	Vp-p
resonant frequency		3,900	4,400	4,900	Hz
resonant impedance				300	$\Omega$
electrostatic capacity	at 100 Hz	14,000	20,000	26,000	pF
dimensions	$\varnothing 27 \times 0.48$				mm
weight			1.4		g
material	brass				
operating temperature		-20		60	$^{\circ}\text{C}$
storage temperature		-20		70	$^{\circ}\text{C}$
hand soldering	brass: for 2.5 seconds max ceramic: for 1 second max			330	$^{\circ}\text{C}$
RoHS	yes			320	$^{\circ}\text{C}$

**MECHANICAL DRAWING**

units: mm

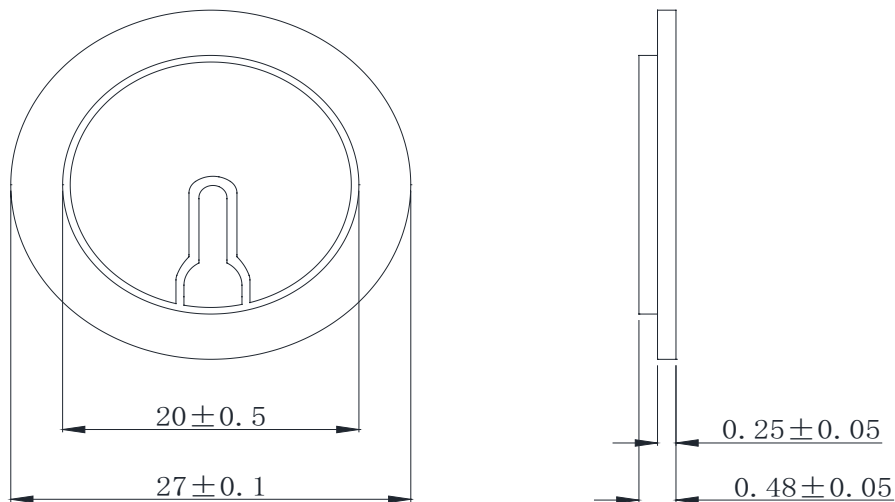

## REVISION HISTORY

rev.	description	date
1.0	initial release	10/17/2024

The revision history provided is for informational purposes only and is believed to be accurate.



Same Sky offers a one (1) year limited warranty. Complete warranty information is listed on our website.

Same Sky reserves the right to make changes to the product at any time without notice. Information provided by Same Sky is believed to be accurate and reliable. However, no responsibility is assumed by Same Sky for its use, nor for any infringements of patents or other rights of third parties which may result from its use.

Same Sky products are not authorized or warranted for use as critical components in equipment that requires an extremely high level of reliability. A critical component is any component of a life support device or system whose failure to perform can be reasonably expected to cause the failure of the life support device or system, or to affect its safety or effectiveness.

[sameskydevices.com](https://www.sameskydevices.com)