

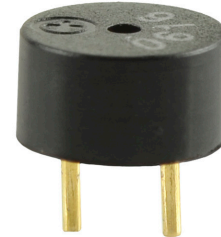

MODEL: CMT-6635C-030 | **DESCRIPTION:** MAGNETIC BUZZER TRANSDUCER

FEATURES

- externally driven
- wave solderable
- rated frequency of 3000 Hz

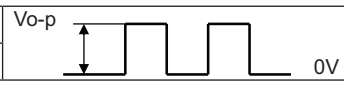

SPECIFICATIONS

| parameter | conditions/description | min | typ | max | units |
|-----------------------|--|-----|-------|-----|-------|
| rated voltage | Vo-p  | | 3.0 | | Vo-p |
| operating voltage | | 2.0 | | 5.0 | Vo-p |
| current consumption | at rated voltage, 3,000 Hz square wave, 1/2 duty | | | 80 | mA |
| rated frequency | | | 3,000 | | Hz |
| sound pressure level | at 10 cm (A-weight), rated voltage, 3,000 Hz square wave, 1/2 duty | 75 | 80 | | dBA |
| coil resistance | | 13 | 16 | 19 | Ω |
| dimensions | ∅6.6 x 3.5 | | | | mm |
| weight | | | 0.4 | | g |
| material | PPD | | | | |
| terminal | pin type [Au plating] | | | | |
| operating temperature | | -20 | | 60 | °C |
| storage temperature | | -30 | | 70 | °C |
| RoHS | yes | | | | |

Notes: 1. All specifications measured at 5-35°C, humidity at 45-85%, under 86-106 kPa pressure, unless otherwise noted.

SOLDERABILITY

| parameter | conditions/description | min | typ | max | units |
|----------------|--|-----|-----|-----|-------|
| wave soldering | see recommended wave soldering profile | | | 250 | °C |

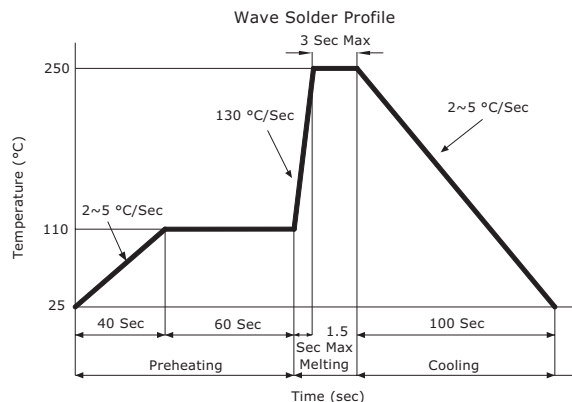

MECHANICAL DRAWING

units: mm
tolerance: ±0.5 mm

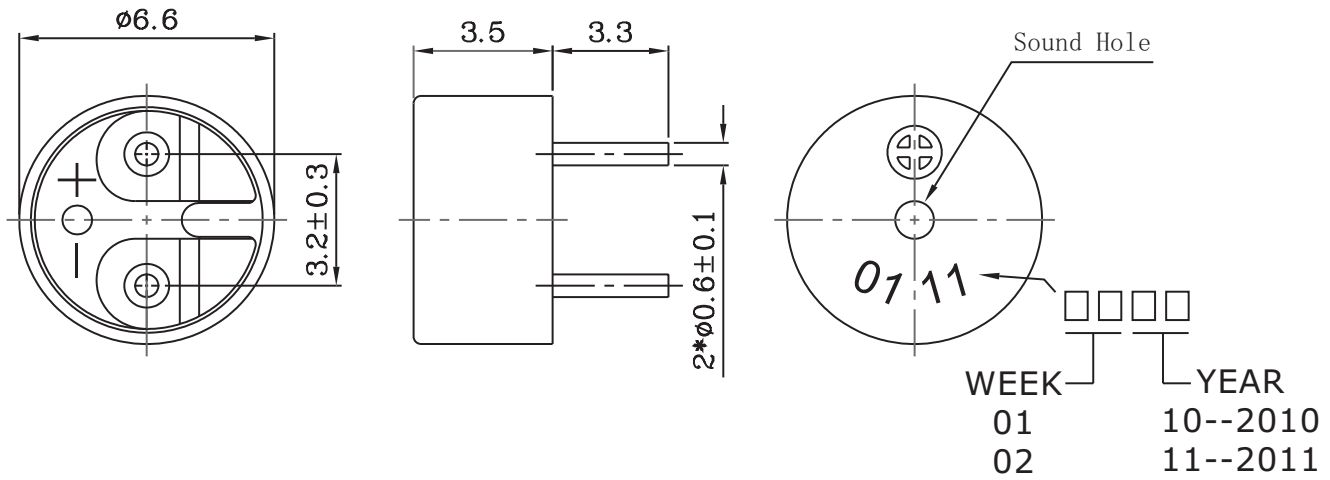

FREQUENCY RESPONSE CURVE

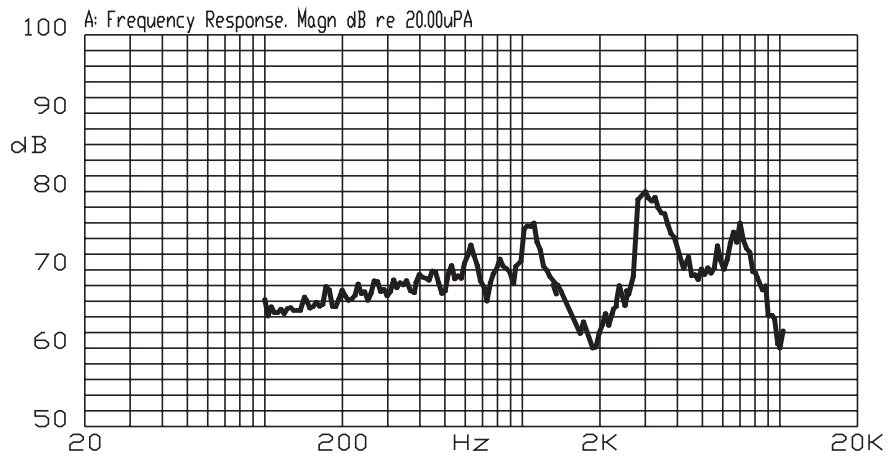

MEASUREMENT METHOD

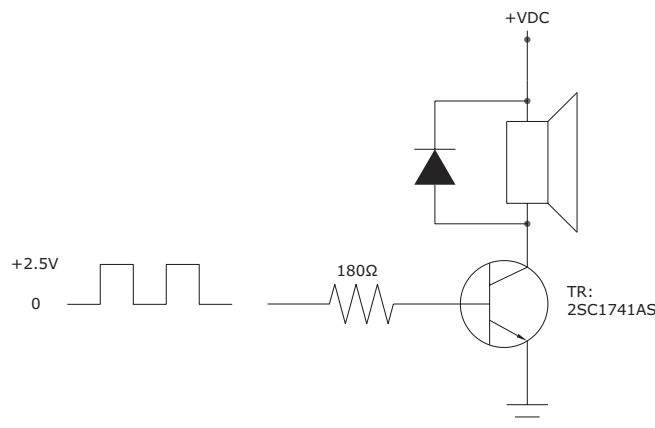

PACKAGING

units: mm

Tray Size: 170 x 170 x 5 mm
 Carton Size: 440 x 400 x 310 mm
 Tray QTY: 225 pcs per tray
 Carton QTY: 13,500 pcs per carton

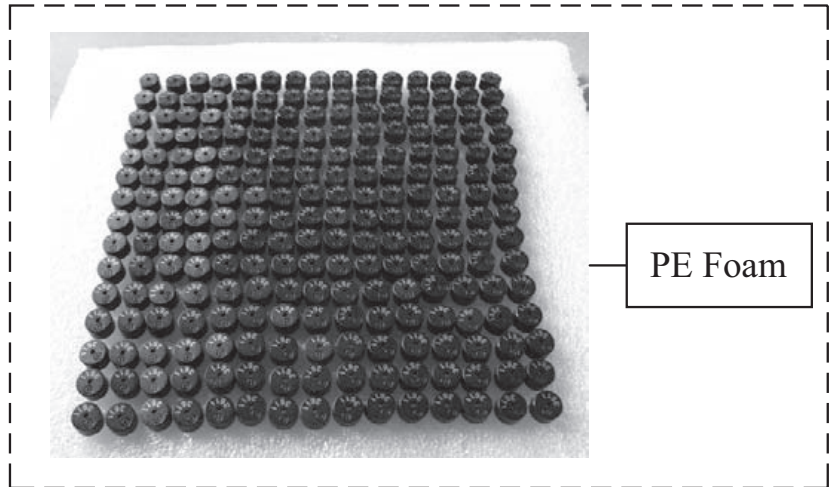

| | |
|---|------------|
| Lot No. | XXXXXXXXXX |
| Model No. | XXXXXXXXXX |
| Quantity. | XXXX Pcs |
| Date: | DD MM YY |
| MADE IN CHINA | |
|  | |

The label is placed on the inner boxes and outer carton.

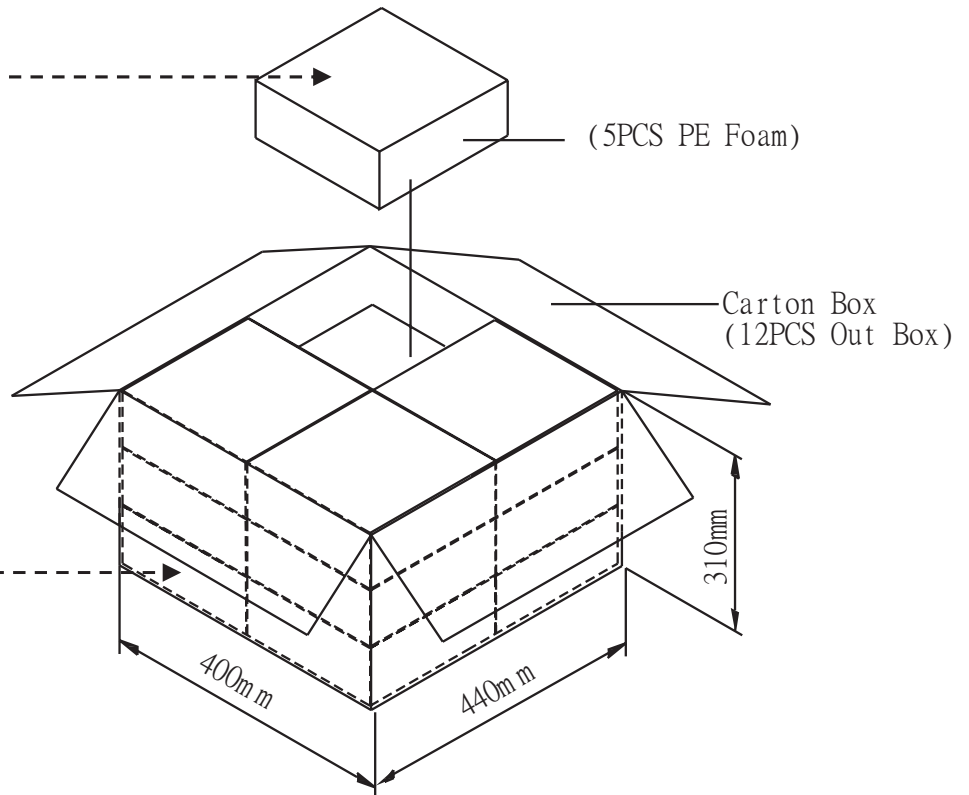

REVISION HISTORY

| rev. | description | date |
|------|-----------------------------------|------------|
| 1.0 | initial release | 03/29/2016 |
| 1.01 | brand update | 11/22/2019 |
| 1.02 | logo, datasheet style update | 08/05/2022 |
| 1.03 | CUI Devices rebranded to Same Sky | 09/11/2024 |

The revision history provided is for informational purposes only and is believed to be accurate.



Same Sky offers a one (1) year limited warranty. Complete warranty information is listed on our website.

Same Sky reserves the right to make changes to the product at any time without notice. Information provided by Same Sky is believed to be accurate and reliable. However, no responsibility is assumed by Same Sky for its use, nor for any infringements of patents or other rights of third parties which may result from its use.

Same Sky products are not authorized or warranted for use as critical components in equipment that requires an extremely high level of reliability. A critical component is any component of a life support device or system whose failure to perform can be reasonably expected to cause the failure of the life support device or system, or to affect its safety or effectiveness.

[sameskydevices.com](https://www.sameskydevices.com)