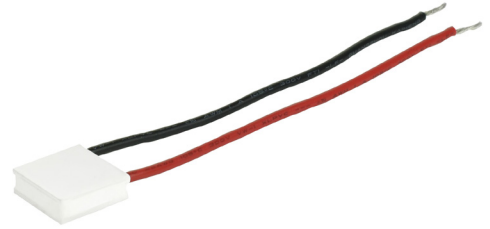

**SERIES:** CP30H | **DESCRIPTION:** PELTIER MODULE**FEATURES**

- arcTEC™ structure on select models
- enhanced reliability for high thermal cycling
- superior thermal performance
- silicon sealed
- wide ΔT max
- low profile
- precise temperature control
- solid state construction

**MODEL**

	input voltage ¹ max [Vdc]	input current ² max [A]	internal resistance ³ typ [$\Omega \pm 10\%$]	output Qmax ⁴		output ΔT max ⁵	
				T _h =27°C [W]	T _h =50°C [W]	T _h =27°C [°C]	T _h =50°C [°C]
CP30138H	3.8	3.0	1.0	7.3	8.0	70	77
CP30238H	8.8	3.0	2.20	16.6	18.0	70	77
CP30239H	6.0	3.0	1.5	10.3	11.3	70	77
CP30301538H	7.6	3.0	1.95	14.7	16.1	70	77
CP303385H ⁶	15.7	3.0	4.0	29.8	32.5	70	77
CP30444 ⁶	19.5	3.0	4.8	34	37	70	77

Notes: 1. Maximum voltage at ΔT max and T_h=27°C
 2. Maximum current to achieve ΔT max
 3. Measured by AC 4-terminal method at 25°C
 4. Maximum heat absorbed at cold side occurs at I_{max}, V_{max}, and $\Delta T=0^\circ\text{C}$
 5. Maximum temperature difference occurs at I_{max}, V_{max}, and Q=0W (ΔT max measured in a vacuum at 1.3 Pa)
 6. Designed with arcTEC™ structure.

SPECIFICATIONS

parameter	conditions/description	min	typ	max	units
solder melting temperature	connection between thermoelectric pairs	235			°C
assembly compression				1	MPa
RoHS	yes				

MECHANICAL DRAWING

units: mm

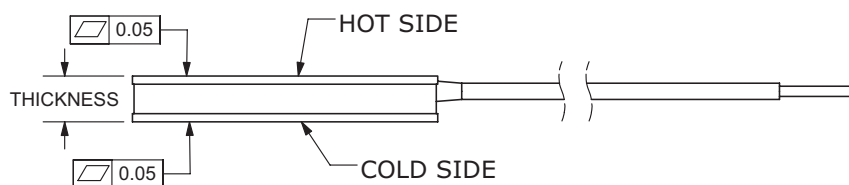

	MATERIAL	PLATING
ceramic plate	96% Al_2O_3	
wire leads [CP30444]	20 AWG	tin
wire leads [all other models]	22 AWG	tin
sealer	silicon rubber 703 RTV (between cold and hot side plates)	
joint cover	silicon rubber 703 RTV	
marking	P/N & S/N printed on cold side surface	

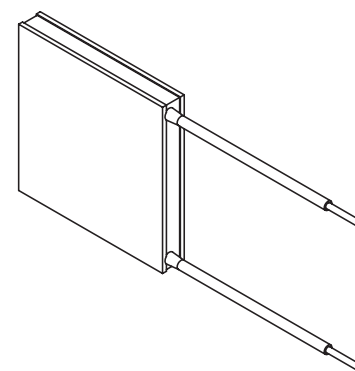
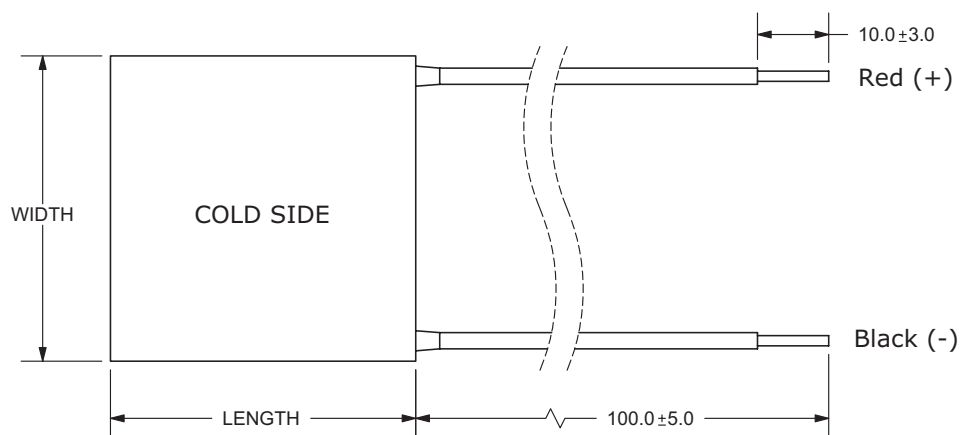

MODEL NO.	LENGTH (mm)	WIDTH (mm)	THICKNESS (mm)
CP30138H	15 ± 0.3	15 ± 0.3	3.8 ± 0.025
CP30238H	20 ± 0.3	20 ± 0.3	3.8 ± 0.025
CP30239H	20 ± 0.3	20 ± 0.3	3.9 ± 0.1
CP30301538H	30 ± 0.3	15 ± 0.3	3.8 ± 0.025
CP303385H	30 ± 0.3	30 ± 0.3	3.85 ± 0.02
CP30444	40 ± 0.3	40 ± 0.3	4.4 ± 0.1

CP30138H PERFORMANCE (Th=27°C)

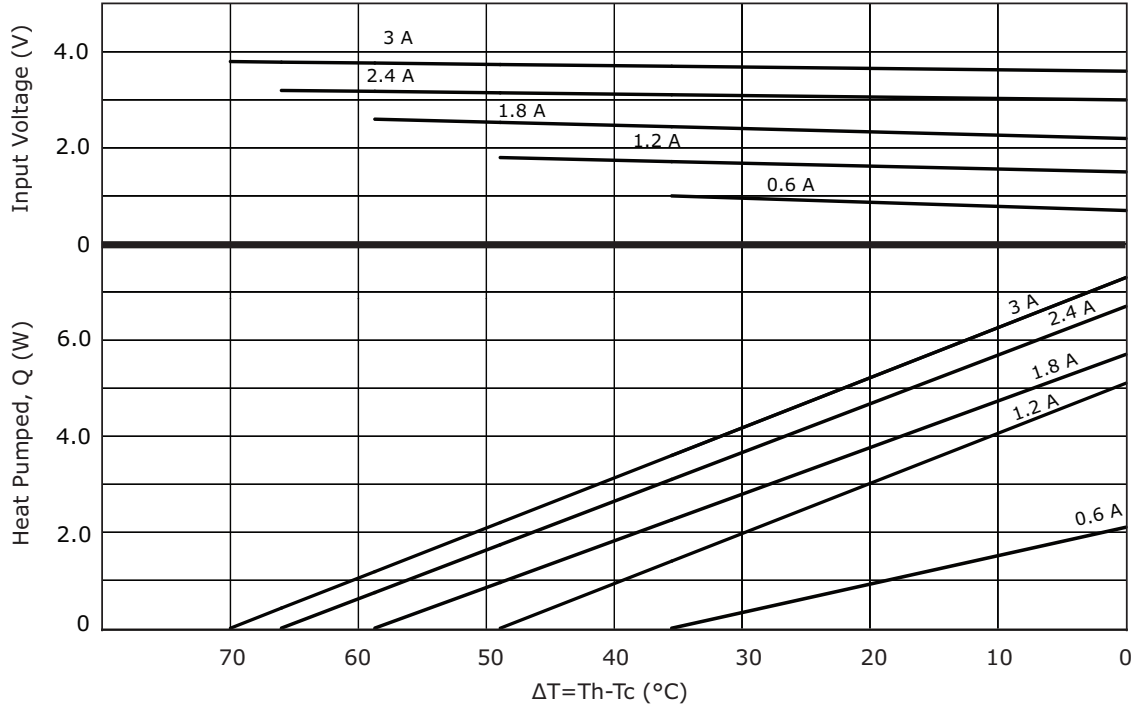

CP30138H PERFORMANCE (Th=50°C)

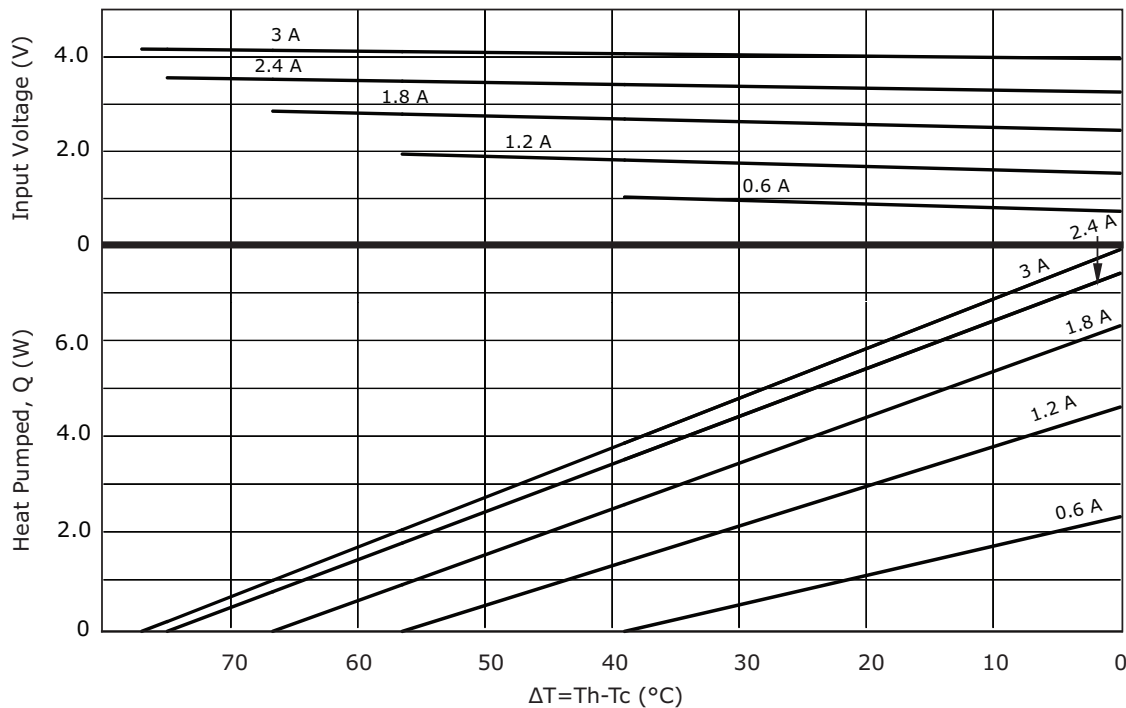

CP30238H PERFORMANCE (Th=27°C)

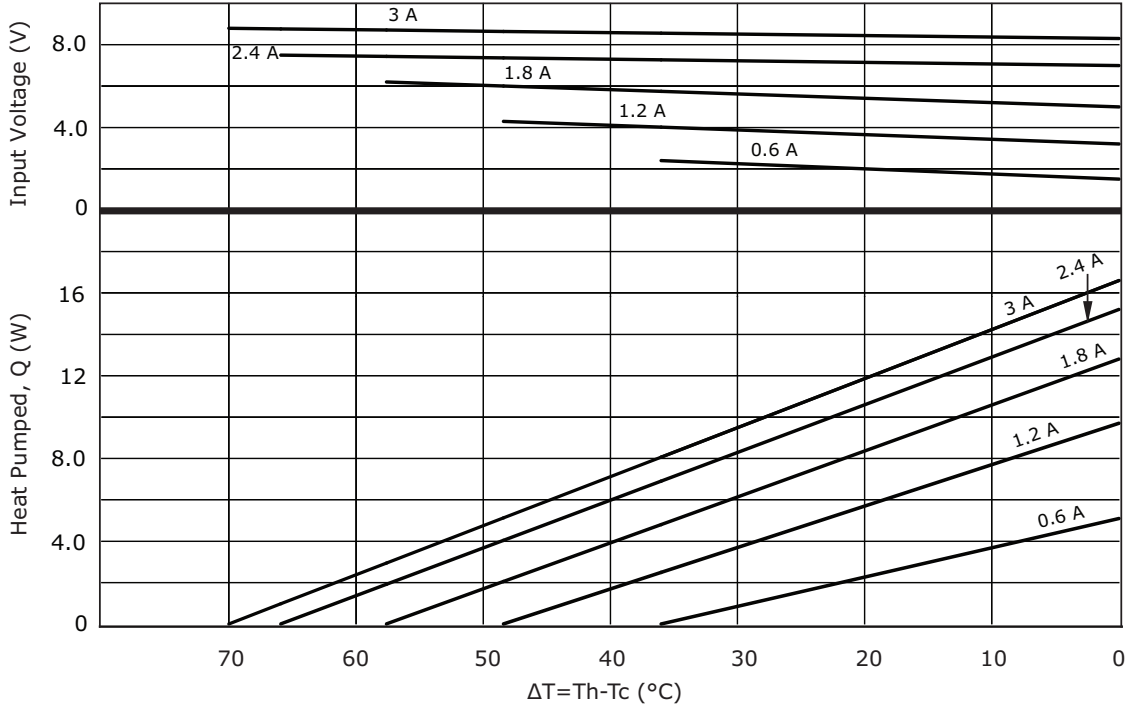

CP30238H PERFORMANCE (Th=50°C)

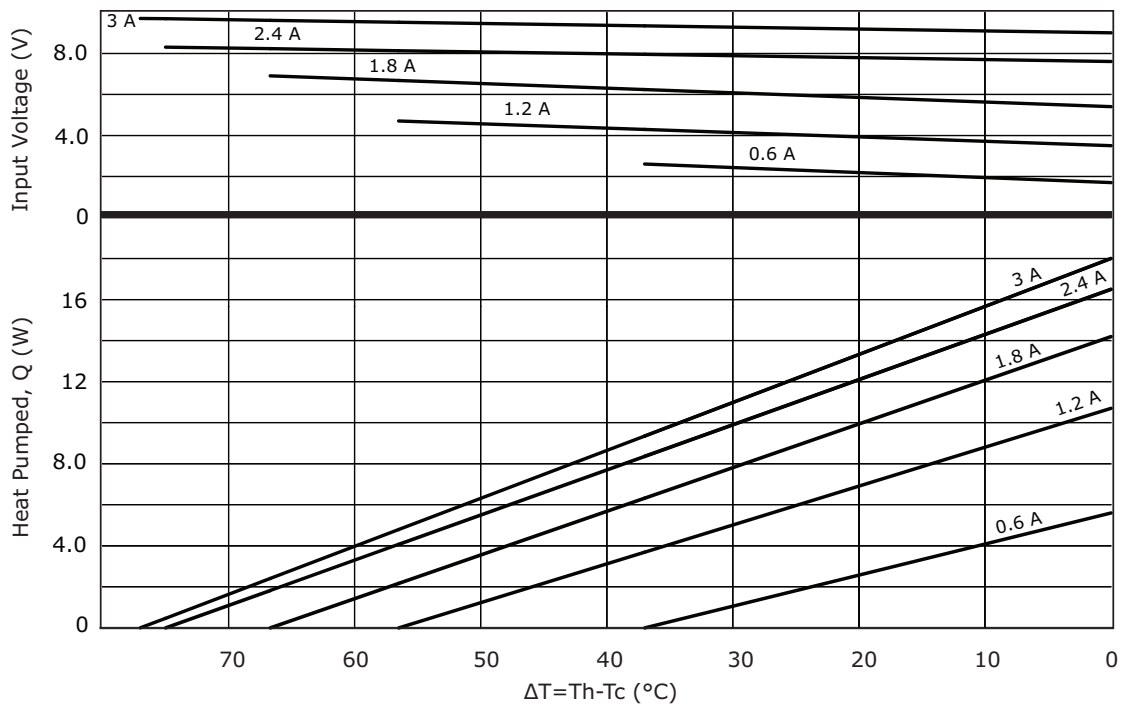

CP30239H PERFORMANCE (Th=27°C)

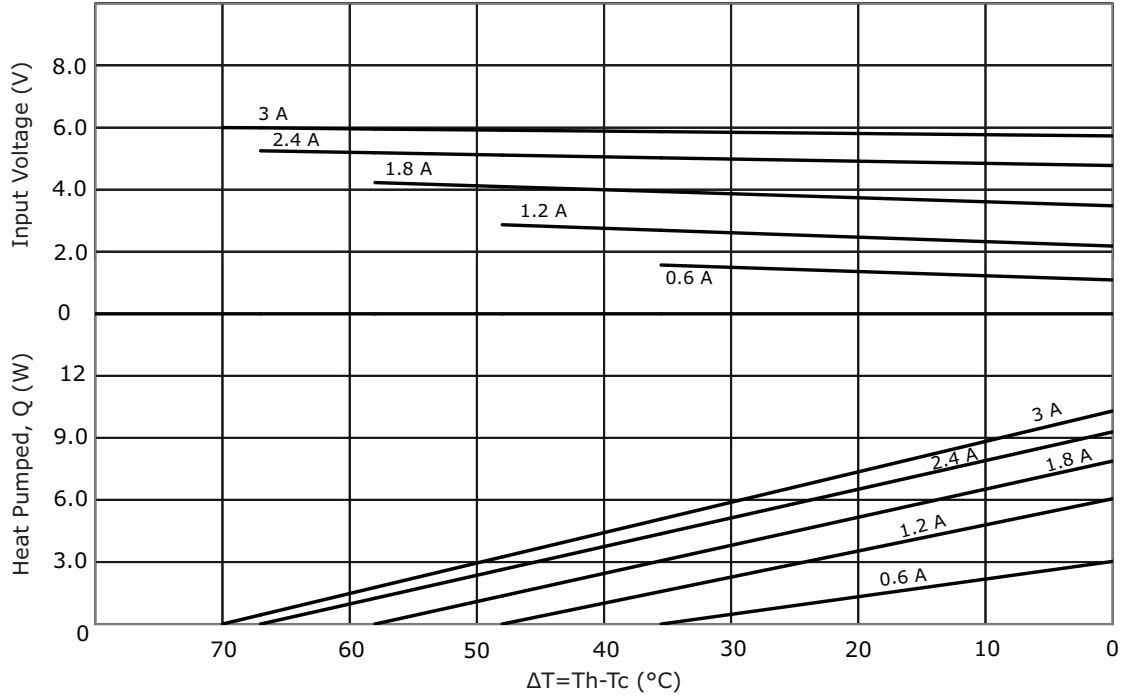

CP30239H PERFORMANCE (Th=50°C)

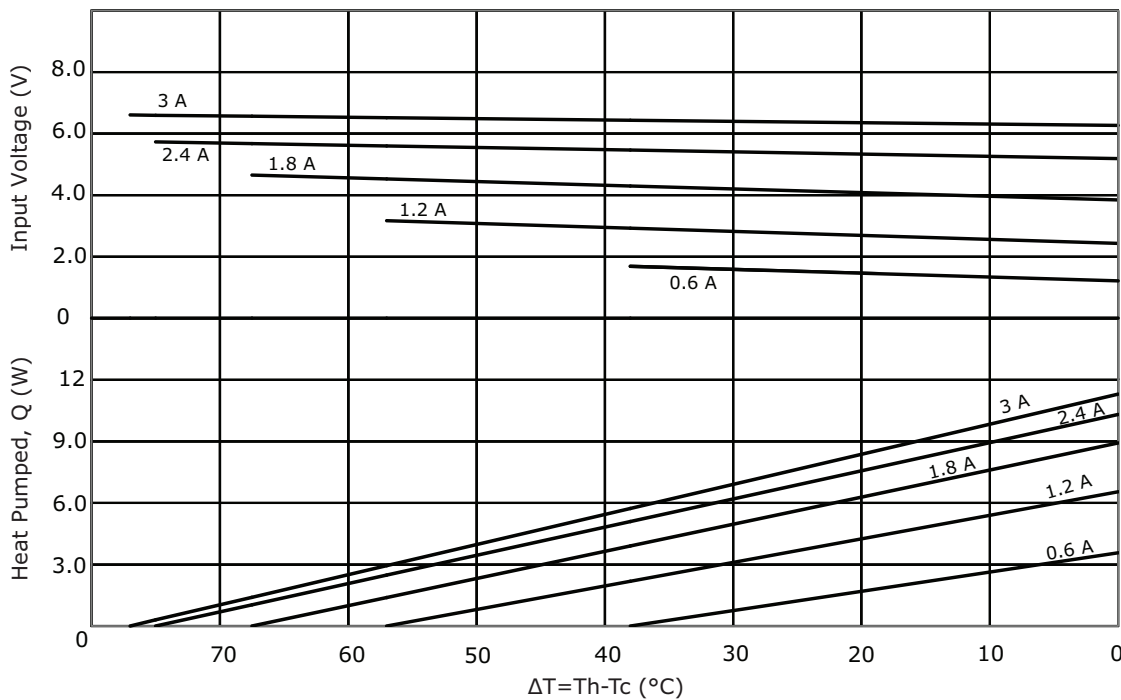

CP30301538H PERFORMANCE (Th=27°C)

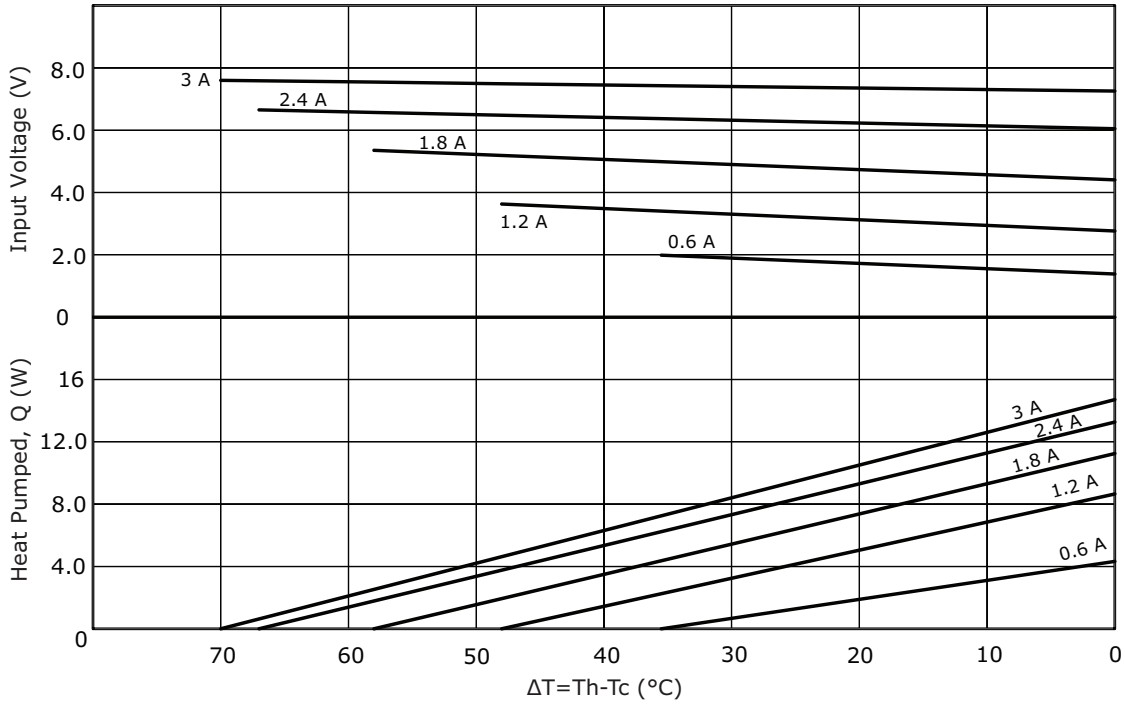

CP30301538H PERFORMANCE (Th=50°C)

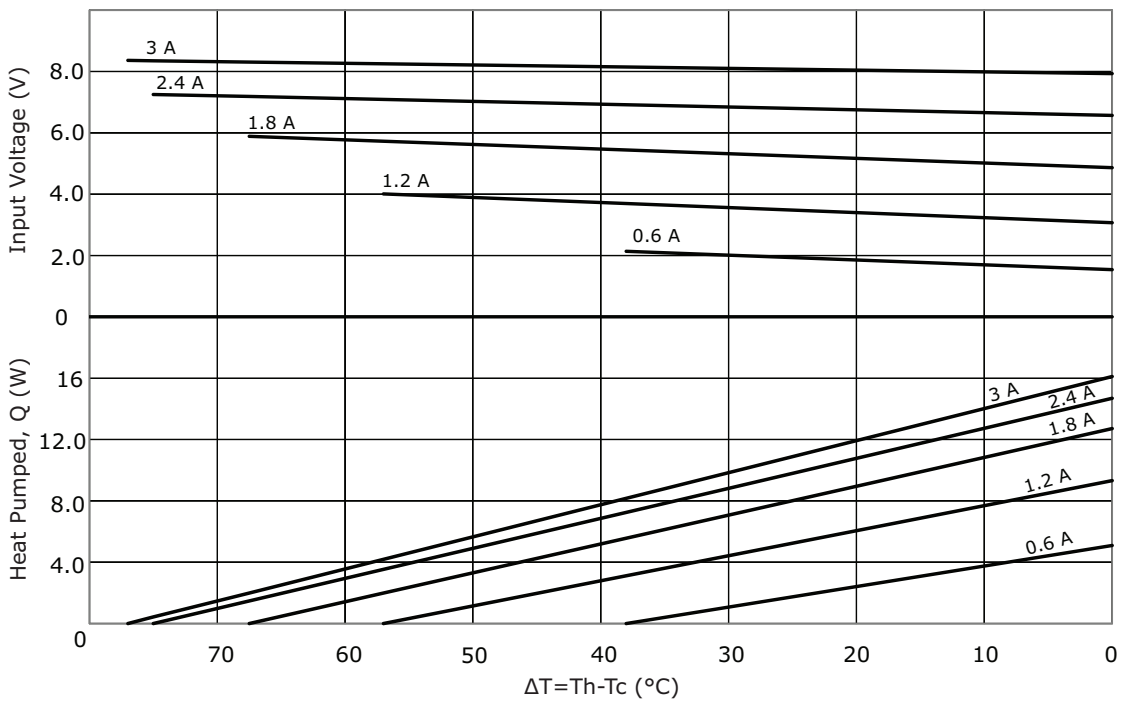

CP303385H PERFORMANCE (Th=27°C)

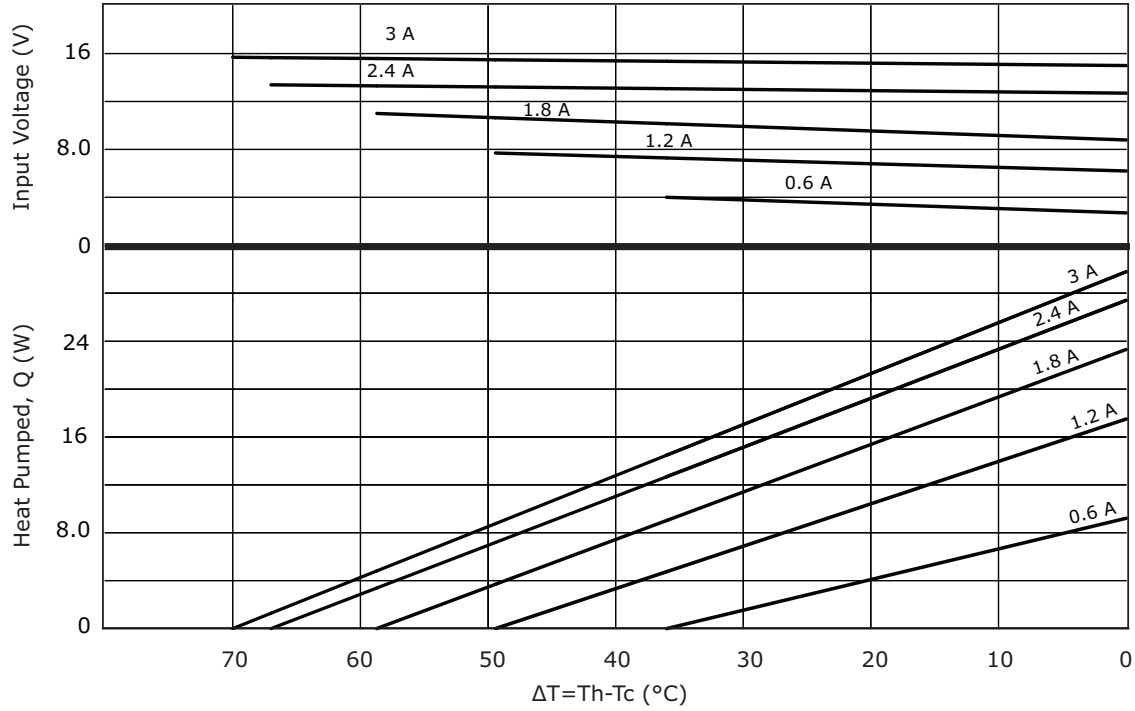

CP303385H PERFORMANCE (Th=50°C)

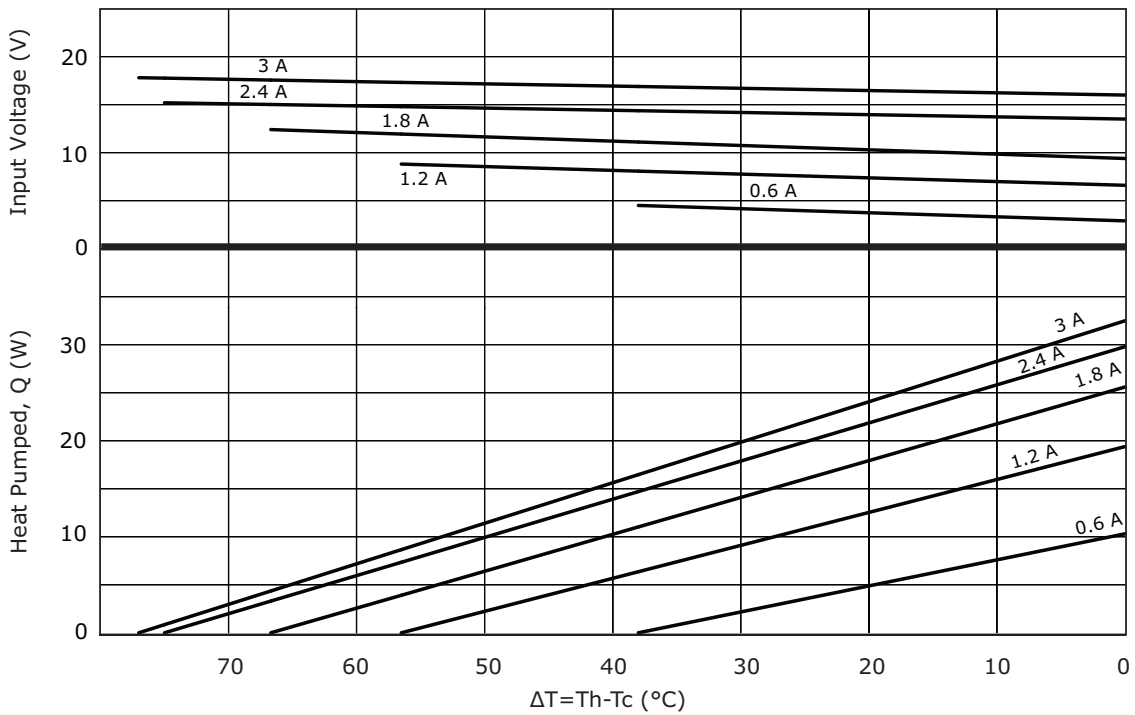

CP30444 PERFORMANCE (Th=27°C)

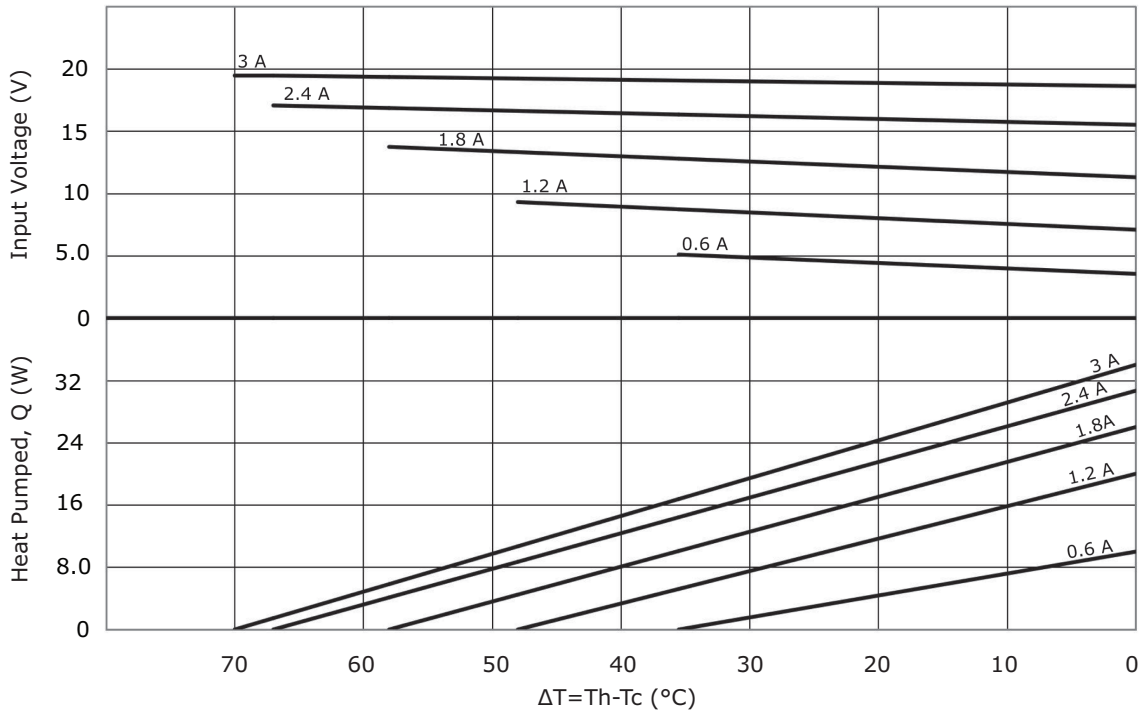

CP30444 PERFORMANCE (Th=50°C)

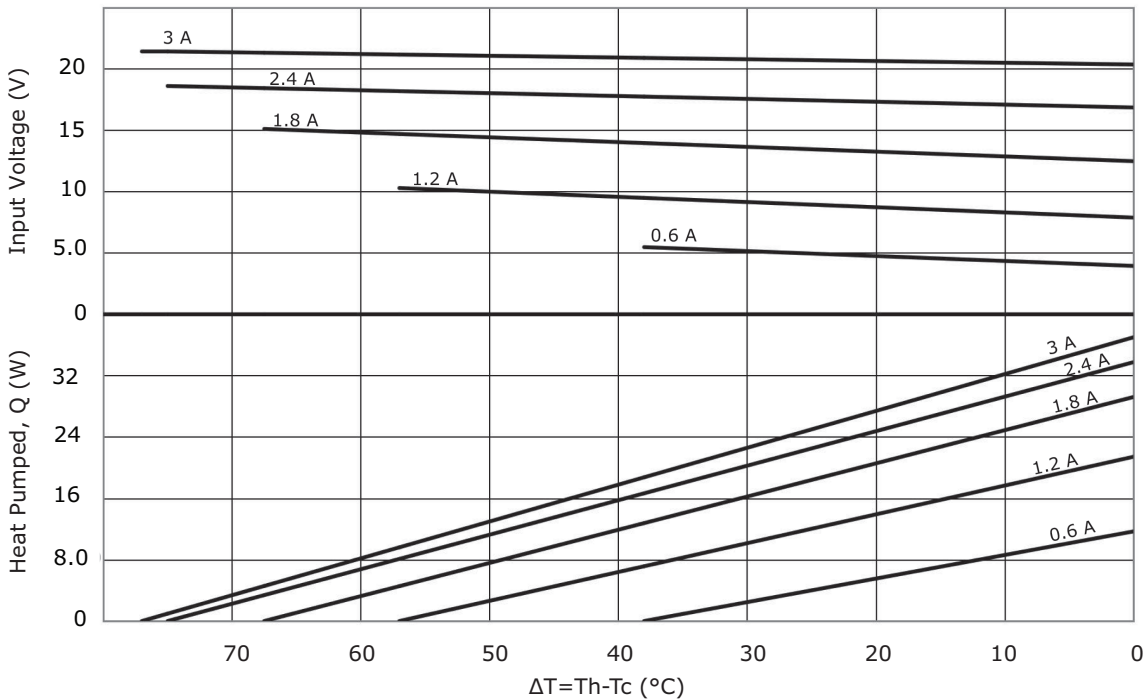

REVISION HISTORY

rev.	description	date
1.0	initial release	09/08/2016
1.01	updated datasheet	09/25/2017
1.02	added new models	05/21/2018
1.03	added model CP30444, brand update	10/18/2019
1.04	logo, datasheet style update	08/05/2022
1.05	CUI Devices rebranded to Same Sky	09/12/2024

The revision history provided is for informational purposes only and is believed to be accurate.



Same Sky offers a one (1) year limited warranty. Complete warranty information is listed on our website.

Same Sky reserves the right to make changes to the product at any time without notice. Information provided by Same Sky is believed to be accurate and reliable. However, no responsibility is assumed by Same Sky for its use, nor for any infringements of patents or other rights of third parties which may result from its use.

Same Sky products are not authorized or warranted for use as critical components in equipment that requires an extremely high level of reliability. A critical component is any component of a life support device or system whose failure to perform can be reasonably expected to cause the failure of the life support device or system, or to affect its safety or effectiveness.

[sameskydevices.com](https://www.sameskydevices.com)