

**MODEL:** CPI-137-24T | **DESCRIPTION:** PIEZO BUZZER INDICATOR

**FEATURES**

- washable
- internally driven
- through hole



**SPECIFICATIONS**

parameter	conditions/description	min	typ	max	units
rated voltage			24		Vdc
operating voltage		16		28	Vdc
current consumption	at rated voltage			18	mA
rated frequency		3,800		4,800	Hz
sound pressure level	at 10 cm, rated voltage	92			dB
tone	continuous				
dimensions	Ø13.9 x 7.5				mm
weight				1.0	g
material	PBT				
terminal	pins (gold plating)				
operating temperature		-40		85	°C
storage temperature		-40		90	°C
washable	yes				
RoHS	yes				

Notes: 1. All specifications measured at 5-35°C, humidity at 45-85%, under 86-106 kPa pressure, unless otherwise noted.

**SOLDERABILITY**

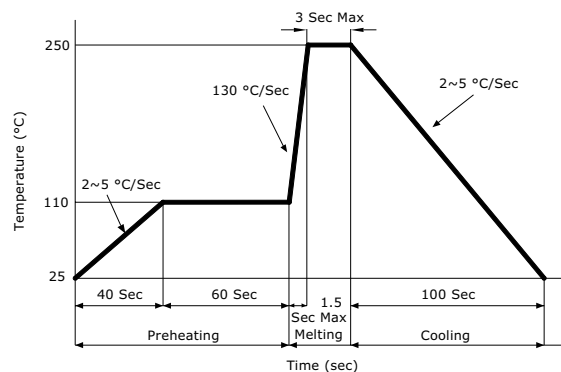
parameter	conditions/description	min	typ	max	units
hand soldering	maximum 2 seconds	330		380	°C
wave soldering	see recommended wave soldering profile			250	°C



## MECHANICAL DRAWING

units: mm  
tolerance: ±0.5 mm

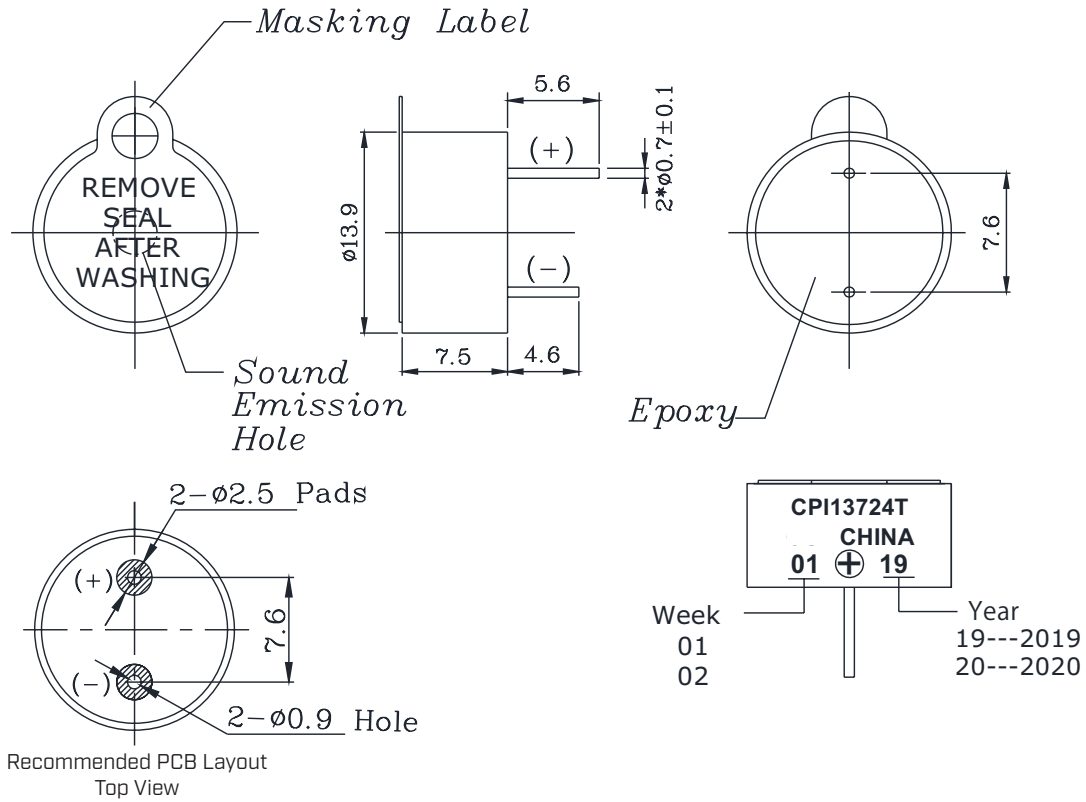

## PERFORMANCE CURVES

Voltage vs. Sound Pressure Level at 10 cm, 25°C

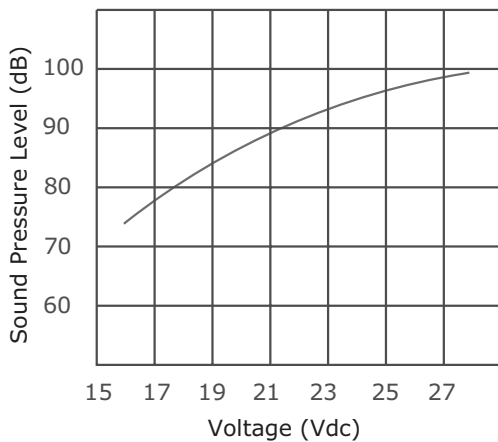

Voltage vs. Current Consumption at 25°C

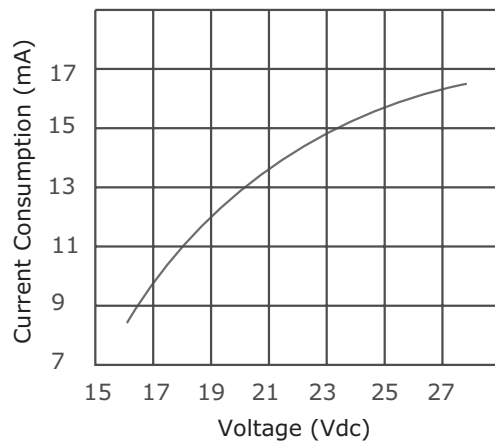

## PACKAGING

units: mm

Inner Egg Tray Size: 184 x 180 x 23 mm  
 Carton Size: 440 x 400 x 310 mm  
 Carton QTY: 6,000 pcs per carton

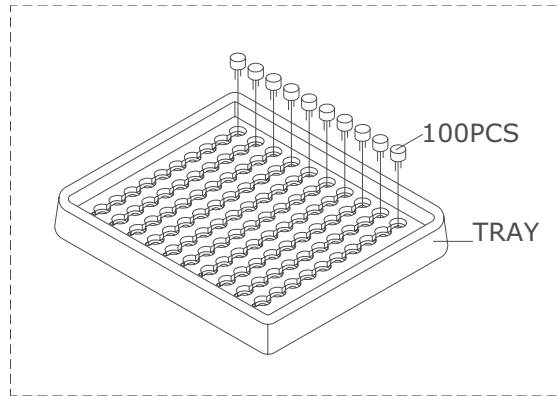

Lot No.	XXXXXXXXXX
Part No.	XXXXXXXXXX XXXXXXXXXX
Quantity	XXXX Pcs
Date:	DD MM YY
MADE IN CHINA	

**RoHs Compliant**

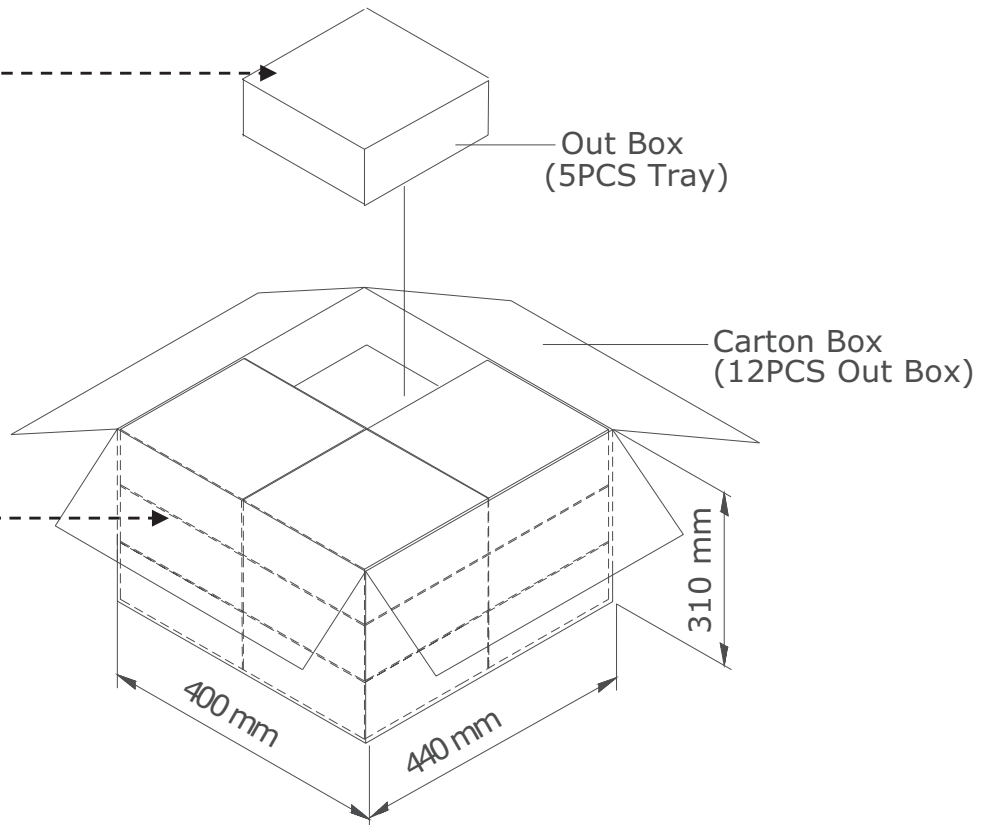

## REVISION HISTORY

rev.	description	date
1.0	initial release	12/10/2019
1.01	logo, datasheet style update	08/05/2022
1.02	CUI Devices rebranded to Same Sky	09/11/2024

The revision history provided is for informational purposes only and is believed to be accurate.



Same Sky offers a one (1) year limited warranty. Complete warranty information is listed on our website.

Same Sky reserves the right to make changes to the product at any time without notice. Information provided by Same Sky is believed to be accurate and reliable. However, no responsibility is assumed by Same Sky for its use, nor for any infringements of patents or other rights of third parties which may result from its use.

Same Sky products are not authorized or warranted for use as critical components in equipment that requires an extremely high level of reliability. A critical component is any component of a life support device or system whose failure to perform can be reasonably expected to cause the failure of the life support device or system, or to affect its safety or effectiveness.

[sameskydevices.com](https://www.sameskydevices.com)