

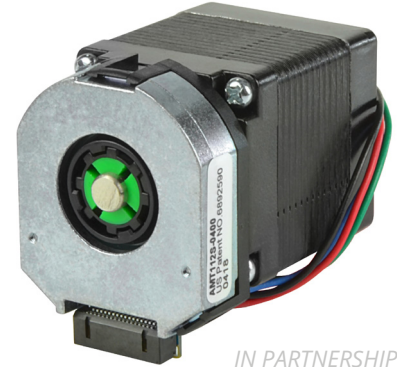

**SERIES:** NEMA11-AMT112S | **DESCRIPTION:** STEPPER SERVO MOTOR

**FEATURES**

- Same Sky AMT112S encoder + LIN Engineering stepper motor
- stepper motor with encoder for closed-loop mode when paired with a controller
- small, compact NEMA 11 frame size
- up to 16.6 oz-in (0.12 N-m) holding torque
- patented capacitive encoder ASIC technology
- incremental resolutions up to 4096 PPR
- resolutions programmable with AMT Viewpoint™ PC software
- digitally set zero position



IN PARTNERSHIP WITH  
 **LIN ENGINEERING**  
 The Step Motor Specialists  
 BACKED BY **MOONS'**

**MODEL**

	step angle	current/phase	resistance/phase typ	inductance/phase typ	max holding torque	max optimal speed	body length
	(°)	[A]	( $\Omega \pm 10\%$ )	(mH $\pm 20\%$ )	[oz-in]	[RPS]	max [inch]
NEMA11-13-01D-AMT112S	1.8	0.67	5.6	3.08	9.2	16	1.26
NEMA11-18-01D-AMT112S	1.8	0.67	7.1	4.79	13.7	13	1.77
NEMA11-18-02D-AMT112S	1.8	1.3	1.3	0.63	12.0	44	1.77
NEMA11-20-01D-AMT112S	1.8	0.67	8.6	6.16	16.6	11	2.01
NEMA11-20-02D-AMT112S	1.8	1.3	1.9	1.46	16.6	22	2.01

## AMT112S ENCODER ELECTRICAL

parameter	conditions/description	min	typ	max	units
power supply	VDD	4.5	5	5.5	V
start up time			200		ms
current consumption	with unloaded output		16		mA
output high level		VDD-0.1			V
output low level				0.1	V
output current (per channel)				15	mA
rise/fall time			8		ns

## INCREMENTAL CHARACTERISTICS

parameter	conditions/description	min	typ	max	units
channels	CMOS Voltage: A, B, Z				
waveform	CMOS voltage square wave				
phase difference	A leads B for CCW rotation (viewed from front)				
quadrature resolutions <sup>1</sup>	48, 96, 100, 125, 192, 200, 250, 256, 360, 384, 400, 500, 512, 768, 800, 1000, 1024, 1600, 2000, 2048, 2500, 4096				PPR
index <sup>2</sup>	one pulse per 360 degree rotation				
accuracy			0.2		degrees
quadrature duty cycle			50		%

Notes: 1. Resolution programmed with AMT Viewpoint™ PC software. Default resolution set to 400 PPR.  
2. Zero position alignment set with AMT One Touch Zero™ module, AMT Viewpoint™ PC software, or serial commands

## MECHANICAL

parameter	conditions/description	min	typ	max	units
weight			15.7		g
rotational speed (at each resolution)	48, 96, 100, 125, 192, 200, 250, 256, 384, 400, 500, 512, 800, 1000, 1024, 2048			8000	RPM
	360, 768, 1600, 2000, 4096			4000	RPM
	2500			2500	RPM

## ENCODER WAVEFORMS



The following parameters are defined by the resolution selected for each encoder, where R = resolution.

Parameter	Description	Expression	Units
T	period	$360/R$	mechanical degrees
P	pulse width	$T/2$	mechanical degrees
I	index width	$P/2$	mechanical degrees
S	A/B state width	$P/2$	mechanical degrees

## STEPPER MOTOR SPECIFICATIONS

parameter	conditions/description	min	typ	max	units
motor frame size	NEMA Size 11				
step angle			1.8		°
rated current/phase	see page 1 for details				
rated voltage			24-48		Vdc
resistance/phase	see page 1 for details				
inductance/phase	see page 1 for details				
connection type	bipolar				
rotor inertia	NEMA11-13-01D-AMT112S		0.05		oz-in <sup>2</sup>
	NEMA11-18-01D-AMT112S, NEMA11-18-02D-AMT112S		0.07		oz-in <sup>2</sup>
	all other models		0.10		oz-in <sup>2</sup>
max holding torque	see page 1 for details				
bearing type	ABEC3				
front shaft OD			5		mm
front shaft length			0.79		inch
max optimal speed	see page 1 for details				
max axial load				2.25	lb
radial play	at 1 lb load			0.001	inch
end play	at 2 lbs load			0.003	inch
shaft run out			0.002		inch TIR
dielectric strength			500		V
EMI/EMC	EN 55014-1:2007				

## SWITCHING SEQUENCE

SWITCHING SEQUENCE					
CCW	STEP	A	A	B	B
↓	1	+	-	+	-
	2	+	-	-	+
	3	-	+	-	+
	4	-	+	+	-
	1	+	-	+	-
Motor Rotation Viewed from Front Shaft End					

## ENVIRONMENTAL

parameter	conditions/description	min	typ	max	units
operating temperature		-20		50	°C
storage temperature		-20		100	°C
humidity	non-condensing			85	%
vibration	10-500 Hz, 5 minute sweep, 2 hours on each XYZ			5	G
shock	3 pulses, 6 ms, 3 on each XYZ			200	G
RoHS	yes				

## TORQUE CURVES

Same Sky P/N NEMA11-13-01D-AMT112S  
Lin Engineering P/N WO-211-13-01 (1.8 Step Motor)  
24 Vdc, 0.67 Amp/Phase, IB462, 1/2 Stepping

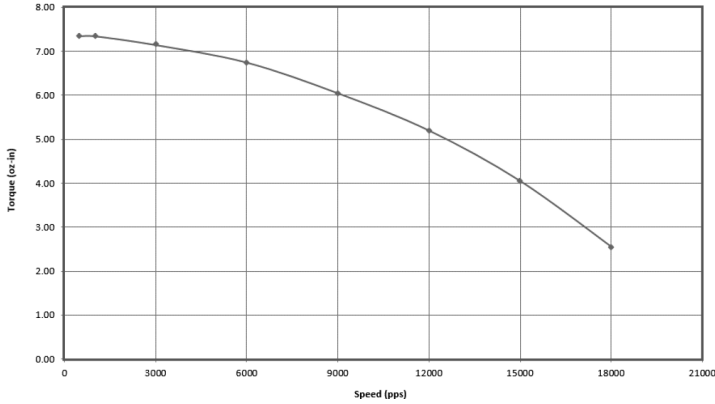

Same Sky P/N NEMA11-18-01D-AMT112S  
Lin Engineering P/N WO-211-18-01 (1.8 Step Motor)  
24 Vdc, 0.67 Amp/Phase, R208, 1/2 Stepping

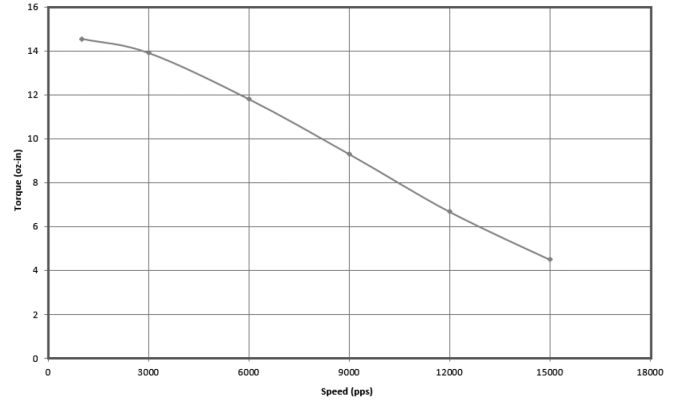

Same Sky P/N NEMA11-18-02D-AMT112S  
Lin Engineering P/N WO-211-18-02 (1.8 Step Motor)  
24 Vdc, 1.3 Amp/Phase, R208, 1/2 Stepping

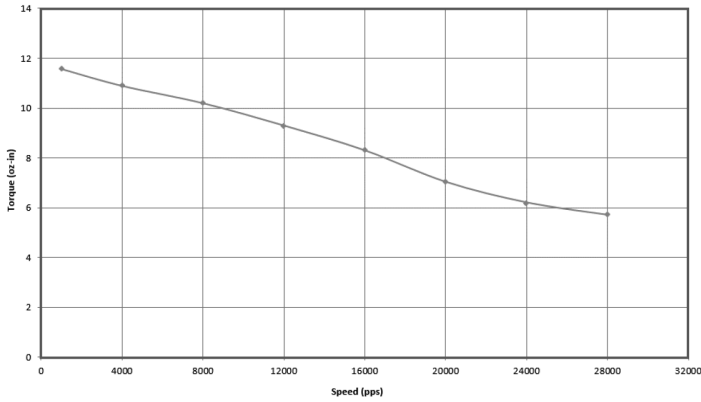

Same Sky P/N NEMA11-20-01D-AMT112S  
Lin Engineering P/N WO-211-20-01 (1.8 Step Motor)  
24 Vdc, 0.67 Amp/Phase, R208, 1/2 Stepping

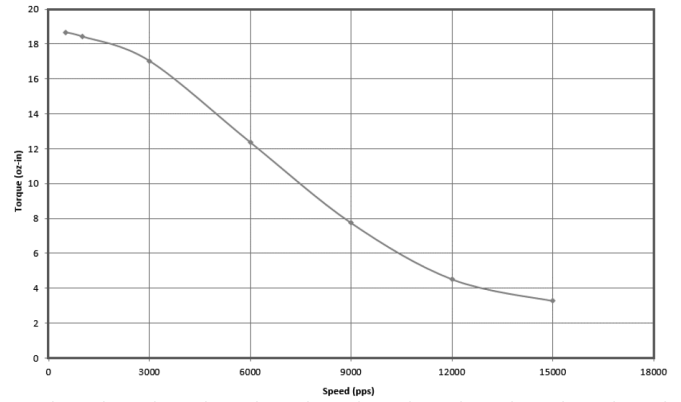

Same Sky P/N NEMA11-20-02D-AMT112S  
Lin Engineering P/N WO-211-20-02 (1.8 Step Motor)  
24 Vdc, 1.3 Amp/Phase, R208, 1/2 Stepping

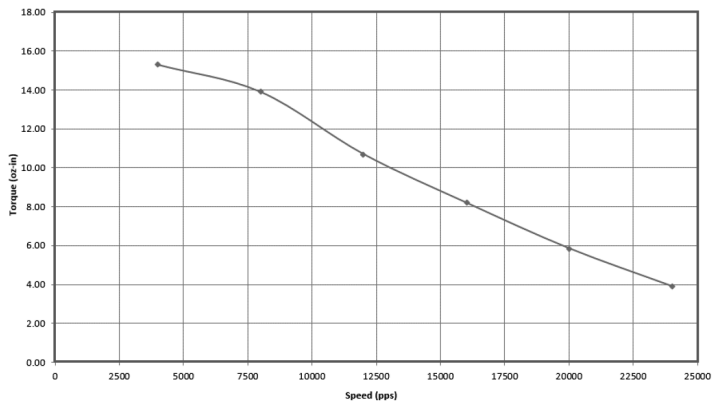

## MECHANICAL DRAWING

units: inch [mm]

tolerance:

X.XX ±0.01 [±0.25]

X.XXX ±0.005 [±0.13]

X.XXXX ±0.0005 [±0.013]

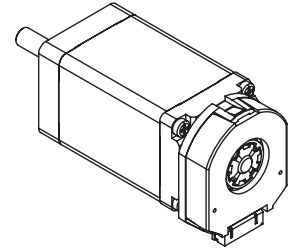
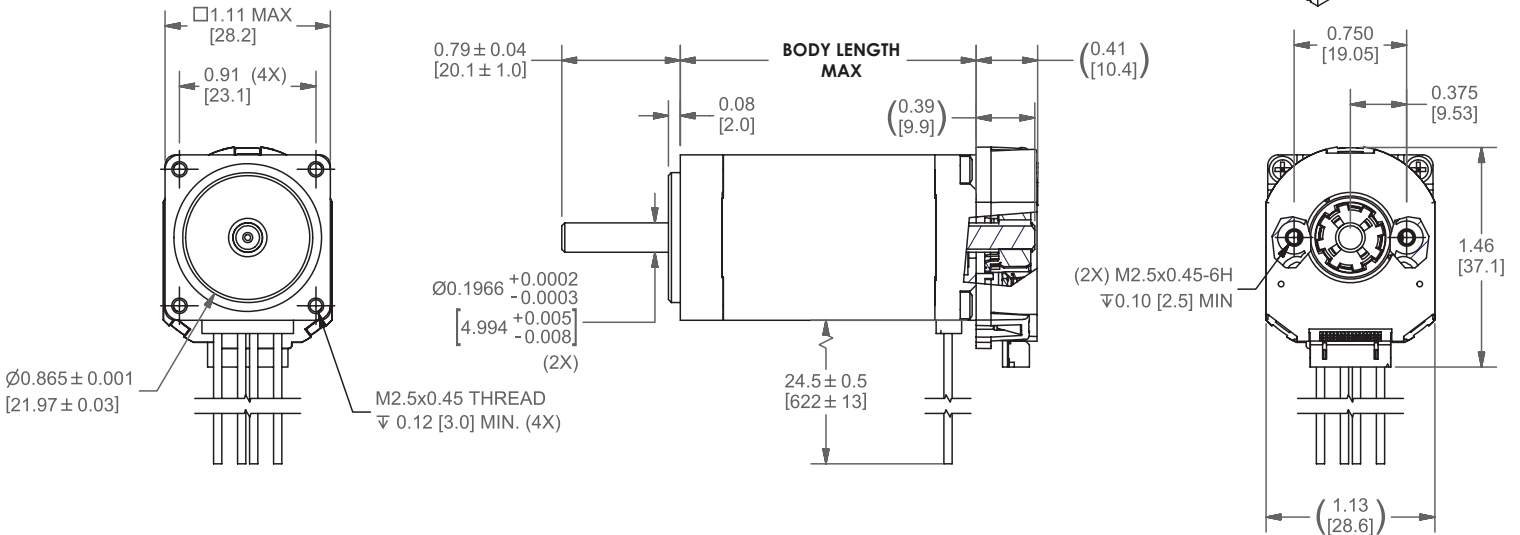

MOTOR WIRE CONNECTIONS	
Color	Function
red	A
blue	$\bar{A}$
green	B
black	$\bar{B}$
26 AWG, PVC	

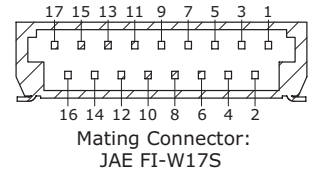

MODEL NO.	BODY LENGTH (inch)	WEIGHT (lb)
NEMA11-13-01D-AMT112S	1.26	0.24
NEMA11-18-01D-AMT112S	1.77	0.35
NEMA11-18-02D-AMT112S	1.77	0.35
NEMA11-20-01D-AMT112S	2.01	0.45
NEMA11-20-02D-AMT112S	2.01	0.45

ENCODER CONNECTIONS	
#	Function
1	TX_ENC+
2	RX_ENC+
3	N/A
4	GND
5	N/A
6	+5 V
7	N/A
8	B+
9	N/A
10	A+
11	N/A
12	Z+
13	N/A
14	MCLR $\bar{B}$
15	N/A
16	N/A
17	N/A

## REVISION HISTORY

rev.	description	date
1.0	initial release	06/26/2018
1.01	brand update	02/20/2020
1.02	logo, datasheet style update	08/05/2022
1.03	CUI Devices rebranded to Same Sky	09/12/2024

The revision history provided is for informational purposes only and is believed to be accurate.



Same Sky offers a one (1) year limited warranty. Complete warranty information is listed on our website.

Same Sky reserves the right to make changes to the product at any time without notice. Information provided by Same Sky is believed to be accurate and reliable. However, no responsibility is assumed by Same Sky for its use, nor for any infringements of patents or other rights of third parties which may result from its use.

Same Sky products are not authorized or warranted for use as critical components in equipment that requires an extremely high level of reliability. A critical component is any component of a life support device or system whose failure to perform can be reasonably expected to cause the failure of the life support device or system, or to affect its safety or effectiveness.

[sameskydevices.com](https://www.sameskydevices.com)