



SERIES: PR26 | **DESCRIPTION:** POWER RELAY

FEATURES

- 40 amp
- 1 form A
- 1 form C
- class B & class F



MODEL

	coil voltage typ (Vdc)	coil resistance [Ω±10%]	operating voltage ¹ min (Vdc)	release voltage max (Vdc)	continuous voltage max (Vdc)	coil power max (mW)
PR26-5V-S-900	5	27	3.75	0.5	7.3	900
PR26-6V-S-900	6	40	4.5	0.6	8.9	900
PR25-9V-S-900	9	97	6.75	0.9	13.9	900
PR26-12V-S-900	12	155	9.0	1.2	17.5	900
PR26-18V-S-900	18	256	11.25	1.8	22.5	900
PR26-24V-S-900	24	380	13.5	2.4	27.4	900
PR26-36V-S-900	36	660	18.0	3.6	36.1	900
PR26-48V-S-900	48	2,560	36.0	4.8	68.4	900

Notes: 1. Relay may pull in with less than operating voltage.
2. All specifications are measured at 23°C unless otherwise specified.

PART NUMBER KEY

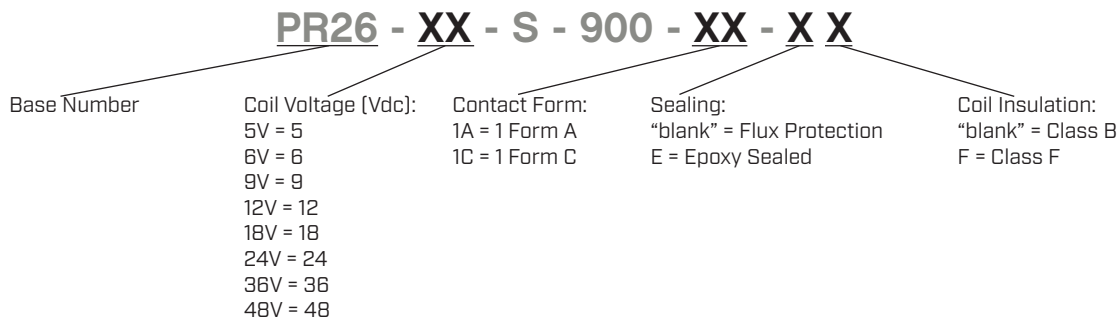

COIL SPECIFICATIONS

parameter	conditions/description	min	typ	max	units
coil power	nominal at pickup voltage		900		mW
			500		mW
coil power continuous dissipation	at 20°C			2.2	W
	at 40°C			1.8	W
temperature rise	at nominal coil voltage		43		K
holding voltage	>35% of nominal coil voltage				

CONTACT SPECIFICATIONS

parameter	conditions/description	min	typ	max	units
contact form	1 Form A, 1 Form C				
contact material	AgSnO ₂ (silver tin oxide)				
contact rating	1 Form A 40 A @ 250 Vac 20 A @ 30 Vac 1 HP @ 250 Vac				
	1 Form C 30/30 A @ 277 Vac NO/NC 20/10 A @ 30 Vdc NO/NC 1/1 HP @ 250 Vac NO/NC				
contact resistance	load contact, voltage drop method			20	mΩ
max switching voltage				300	Vac
				30	Vdc
max switching current	Vac			40	A
	Vdc			40	A
max switching power	Vac			10,000	VA
	Vdc			900	W
life	electrical: at 125 Vac, 30 A, N-O	100,000			operations
	mechanical	10,000,000			operations

GENERAL SPECIFICATIONS

parameter	conditions/description	min	typ	max	units
insulation resistance	at 500 Vdc, 20 °C, 50% RH	1,000			MΩ
dielectric strength	between open contacts for 1 minute at sea level		1,500		Vrms
	between coil and contacts for 1 minute at sea level		2,500		Vrms
operate time	at nominal coil voltage		8	12	ms
release time	at nominal coil voltage, without coil suppression		3.5	5	ms
shock resistance			20		G
vibration resistance	10-55 Hz, 1.5 mm double amplitude				
operating temperature	Class B models at nominal coil voltage	-55		85	°C
	Class F models at nominal coil voltage	-55		105	°C
weight			25		g
safety approvals	UL/cUL 508				
flammability rating	UL94V-0				
RoHS	yes				
packaging	tray: 40 pcs per tray carton QTY: 400 pcs per carton				

SOLDERABILITY

parameter	conditions/description	min	typ	max	units
wave soldering	for max 5 seconds			270	°C
washable	only on epoxy sealed models max imersion time of 30 seconds			80	°C

MECHANICAL DRAWING (1A = 1 FORM A)

units: mm [inch]
 tolerance: ± 0.254 mm
 unless otherwise noted

DESCRIPTION	MATERIAL	PLATING/COLOR
housing	PBT [UL94V-0]	black
terminals	copper alloy	tin

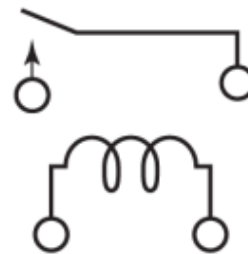
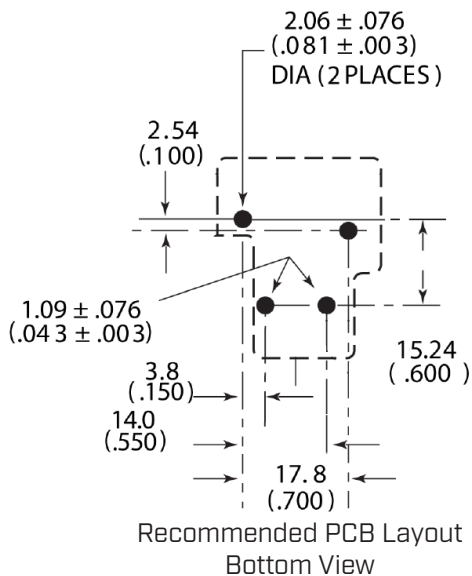
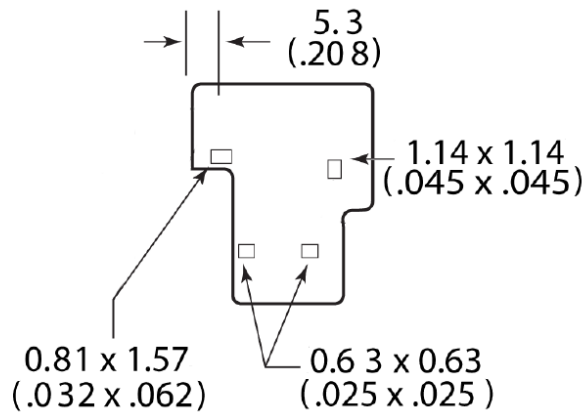
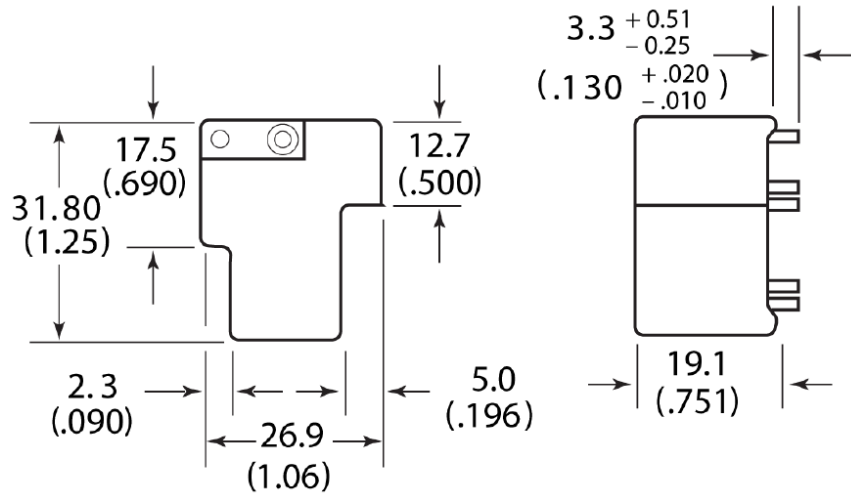

MECHANICAL DRAWING (1C = 1 FORM C)

units: mm [inch]
 tolerance: ±0.254 mm
 unless otherwise noted

DESCRIPTION	MATERIAL	PLATING/COLOR
housing	PBT [UL94V-0]	black
terminals	copper alloy	tin

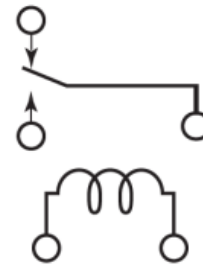
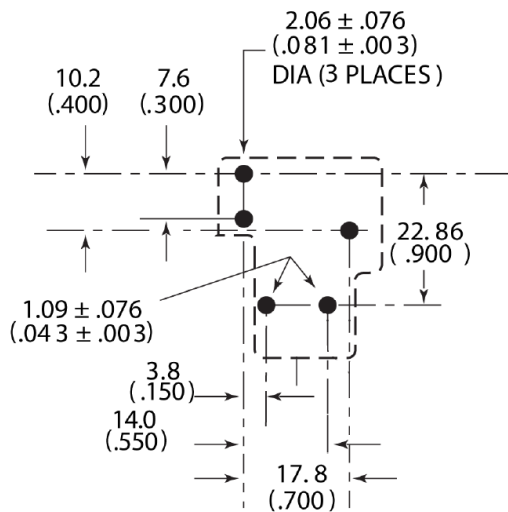
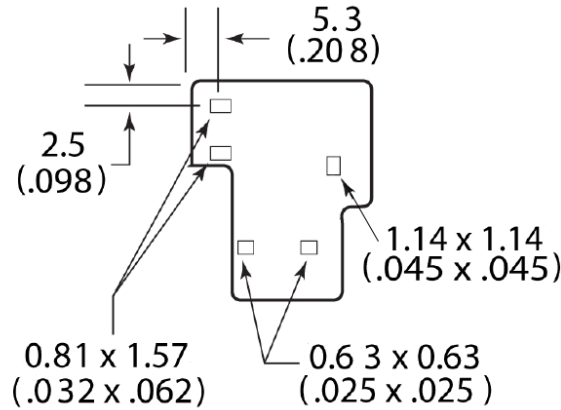
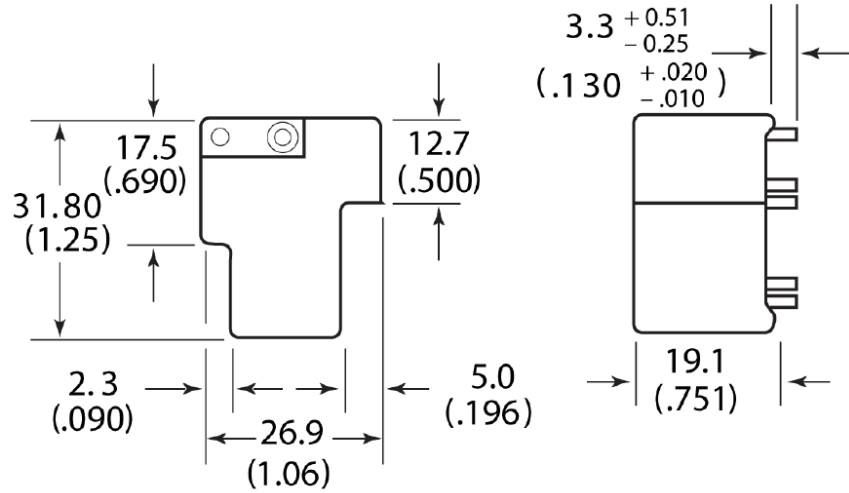

Recommended PCB Layout
Bottom View

Wiring Diagram
Bottom View

CHARACTERISTIC CURVES

Coil Temperature Rise

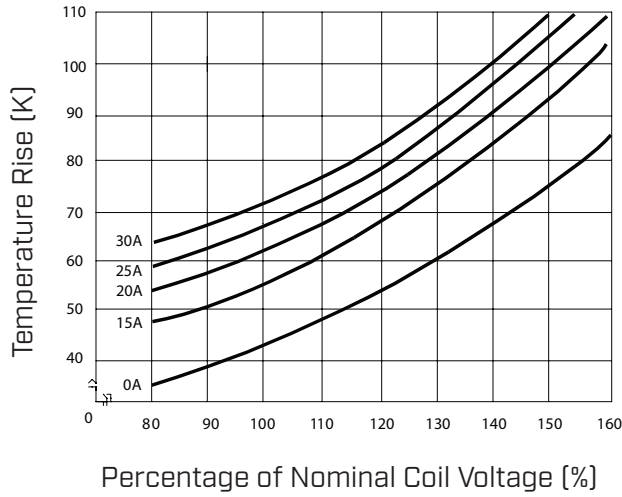

Life Curve

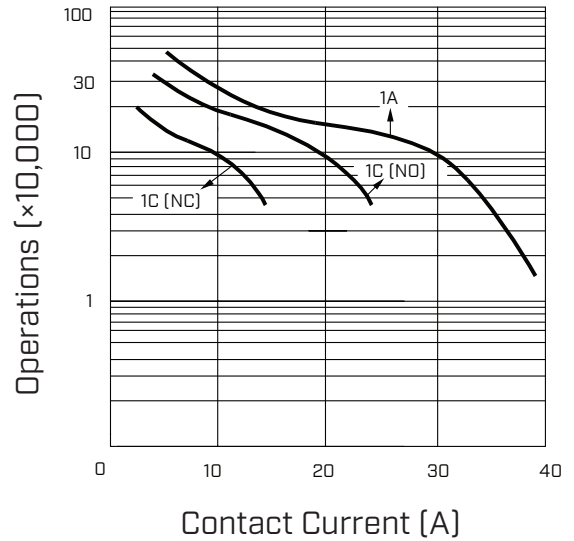

Maximum Switching Power

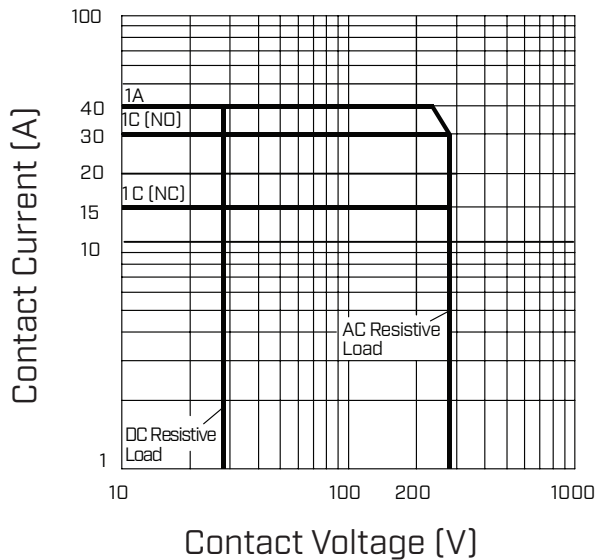

Test Conditions:
Resistive load, unsealed, room temp, 1 second on 9 seconds off

REVISION HISTORY

rev.	description	date
1.0	initial release	02/14/2024
1.01	CUI Devices rebranded to Same Sky	09/12/2024

The revision history provided is for informational purposes only and is believed to be accurate.



Same Sky offers a one (1) year limited warranty. Complete warranty information is listed on our website.

Same Sky reserves the right to make changes to the product at any time without notice. Information provided by Same Sky is believed to be accurate and reliable. However, no responsibility is assumed by Same Sky for its use, nor for any infringements of patents or other rights of third parties which may result from its use.

Same Sky products are not authorized or warranted for use as critical components in equipment that requires an extremely high level of reliability. A critical component is any component of a life support device or system whose failure to perform can be reasonably expected to cause the failure of the life support device or system, or to affect its safety or effectiveness.

[sameskydevices.com](https://www.sameskydevices.com)