

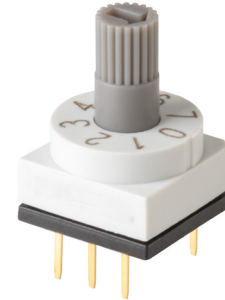

**SERIES:** RDS4-1065-D-67 | **DESCRIPTION:** ROTARY DIP SWITCH

**FEATURES**

- 4, 8, 10, 16 positions
- through hole
- IP67



**SPECIFICATIONS**

parameter	conditions/description	min	typ	max	units
rated voltage	switching			42	Vdc
	non-switching			42	Vdc
rated current	switching			150	mA
	non-switching			200	mA
withstanding voltage	for 1 minute		250		Vac
contact resistance				80	mΩ
insulation resistance	for 1 minute at 250 Vdc	100			MΩ
operating torque				700	gf*cm
actuator travel	continuous rotation		360		degrees
operating temperature		-40		85	°C
storage temperature		-40		85	°C
life	at 42 Vdc, 150 mA, 15~20 cycles/minute		10,000		steps
flammability rating	see material tables				
RoHS	yes				
IP level	IP67				

**SOLDERABILITY**

parameter	conditions/description	min	typ	max	units
hand soldering	for maximum 3 seconds			350	°C
wave soldering	for maximum 5 seconds			260	°C

**PART NUMBER KEY**

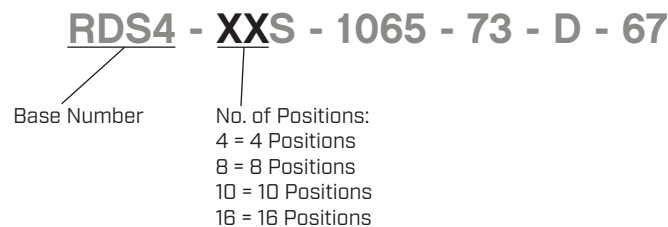

## MECHANICAL DRAWING (4 POSITION)

units: mm  
 tolerance: ±0.3 mm  
 unless otherwise specified

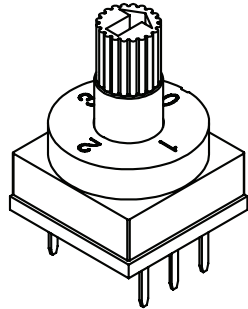

DESCRIPTION	MATERIAL	PLATING/COLOR
actuator	POM (UL94HB)	gray
cover	PA66 (UL94V-0)	light white
base	PA66 (UL94V-0)	black
terminals	phosphorus bronze	Ni/Au

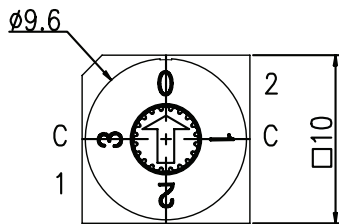

ON ●	CODE			
	POS	C	1	2
OFF ○				
4 POSITION	0	●	○	○
	1	●	●	○
	2	●	○	●
	3	●	●	●

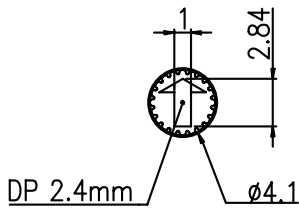

ACTUATOR

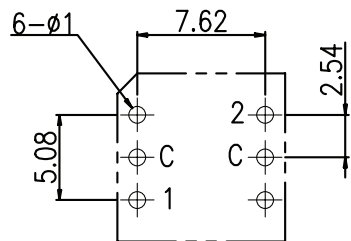
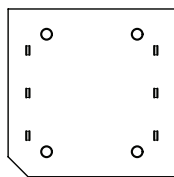
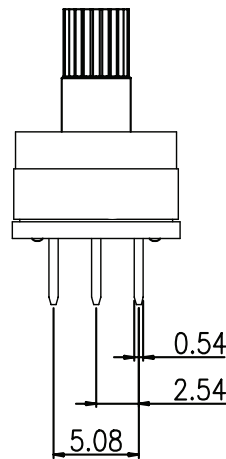
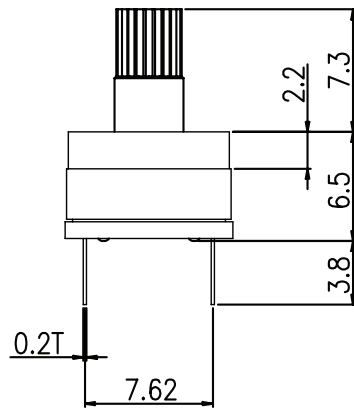

Recommended PCB Layout  
 Top View

## MECHANICAL DRAWING (8 POSITION)

units: mm  
 tolerance: ±0.3 mm  
 unless otherwise specified

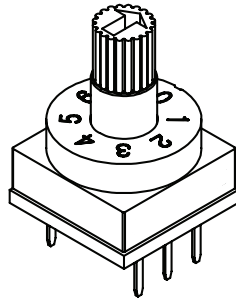

DESCRIPTION	MATERIAL	PLATING/COLOR
actuator	POM (UL94HB)	gray
cover	PA66 (UL94V-0)	light white
base	PA66 (UL94V-0)	black
terminals	phosphorus bronze	Ni/Au

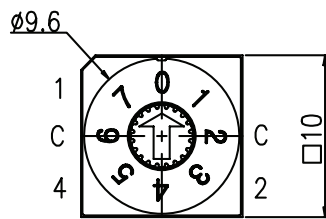

ON ●					
	OFF ○	CODE			
TYPE	POS	C	1	2	4
8 POSITION	0	●	○	○	○
	1	●	●	○	○
	2	●	○	●	○
	3	●	●	●	○
	4	●	○	○	●
	5	●	●	○	●
	6	●	○	●	●
	7	●	●	●	●

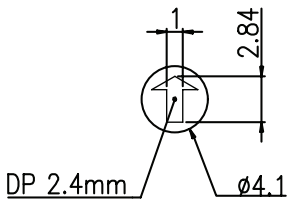

ACTUATOR

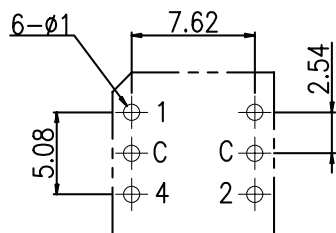
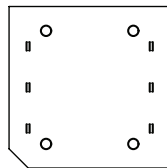
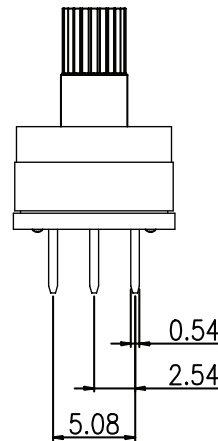
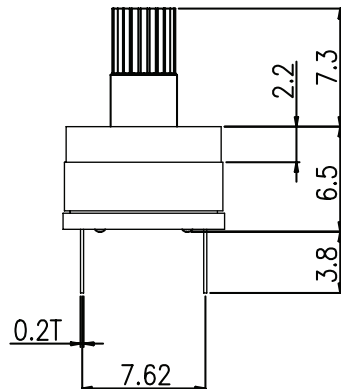

Recommended PCB Layout  
 Top View

## MECHANICAL DRAWING (10 POSITION)

units: mm  
 tolerance: ±0.3 mm  
 unless otherwise specified

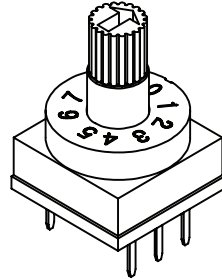

DESCRIPTION	MATERIAL	PLATING/COLOR
actuator	POM (UL94HB)	gray
cover	PA66 (UL94V-0)	light white
base	PA66 (UL94V-0)	black
terminals	phosphorus bronze	Ni/Au

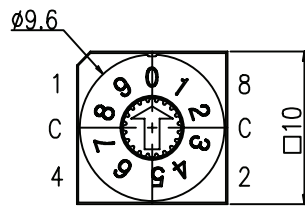

TYPE	POS	CODE					
		C	1	2	4	8	
10 POSITION	0	●	○	○	○	○	
	1	●	●	○	○	○	
	2	●	○	●	○	○	
	3	●	●	●	○	○	
	4	●	○	○	●	○	
	5	●	●	○	●	○	
	6	●	○	●	●	○	
	7	●	●	●	●	○	
	8	●	○	○	○	●	
	9	●	●	○	○	●	

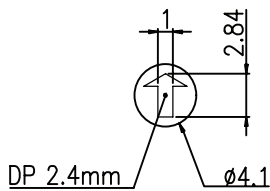

ACTUATOR

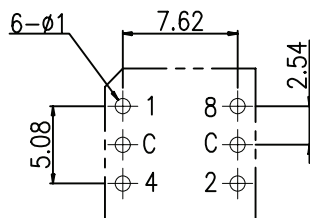
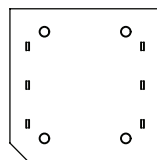
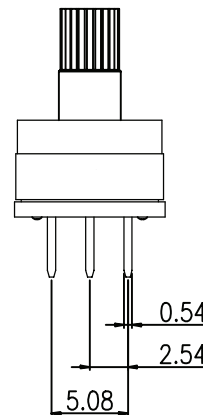
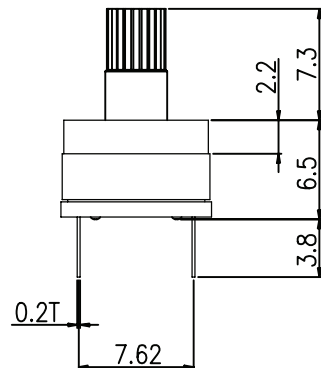

Recommended PCB Layout  
 Top View

## MECHANICAL DRAWING (16 POSITION)

units: mm  
 tolerance: ±0.3 mm  
 unless otherwise specified

DESCRIPTION	MATERIAL	PLATING/COLOR
actuator	POM (UL94HB)	gray
cover	PA66 (UL94V-0)	light white
base	PA66 (UL94V-0)	black
terminals	phosphorus bronze	Ni/Au

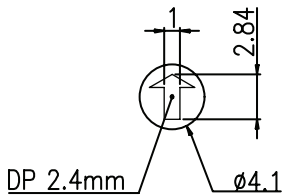
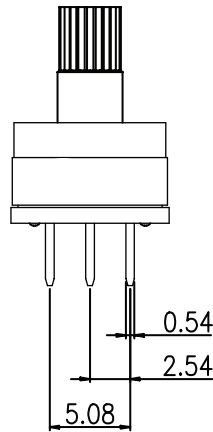
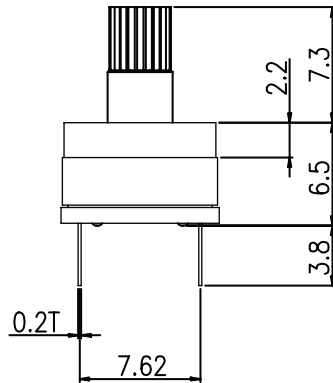
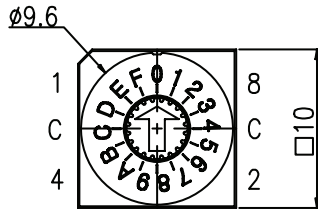
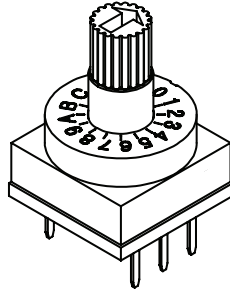

ACTUATOR

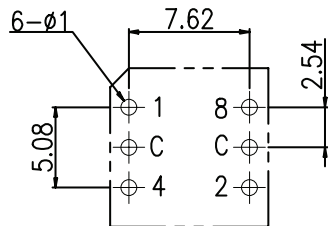
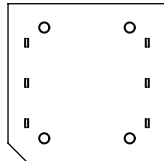

Recommended PCB Layout  
 Top View

ON ●						
OFF ○	CODE					
TYPE	POS	C	1	2	4	8
16 POSITION	0	●	○	○	○	○
	1	●	●	○	○	○
	2	●	○	●	○	○
	3	●	●	●	○	○
	4	●	○	○	●	○
	5	●	●	○	●	○
	6	●	○	●	●	○
	7	●	●	●	●	○
	8	●	○	○	○	●
	9	●	●	○	○	●
	A	●	○	●	○	●
	B	●	●	●	○	●
	C	●	○	○	●	●
D	●	●	○	●	●	
E	●	○	●	●	●	
F	●	●	●	●	●	

## PACKAGING

units: mm

Tube Size: 20.7 x 16.2 x 540 mm  
Tube QTY: 50 pcs per tube

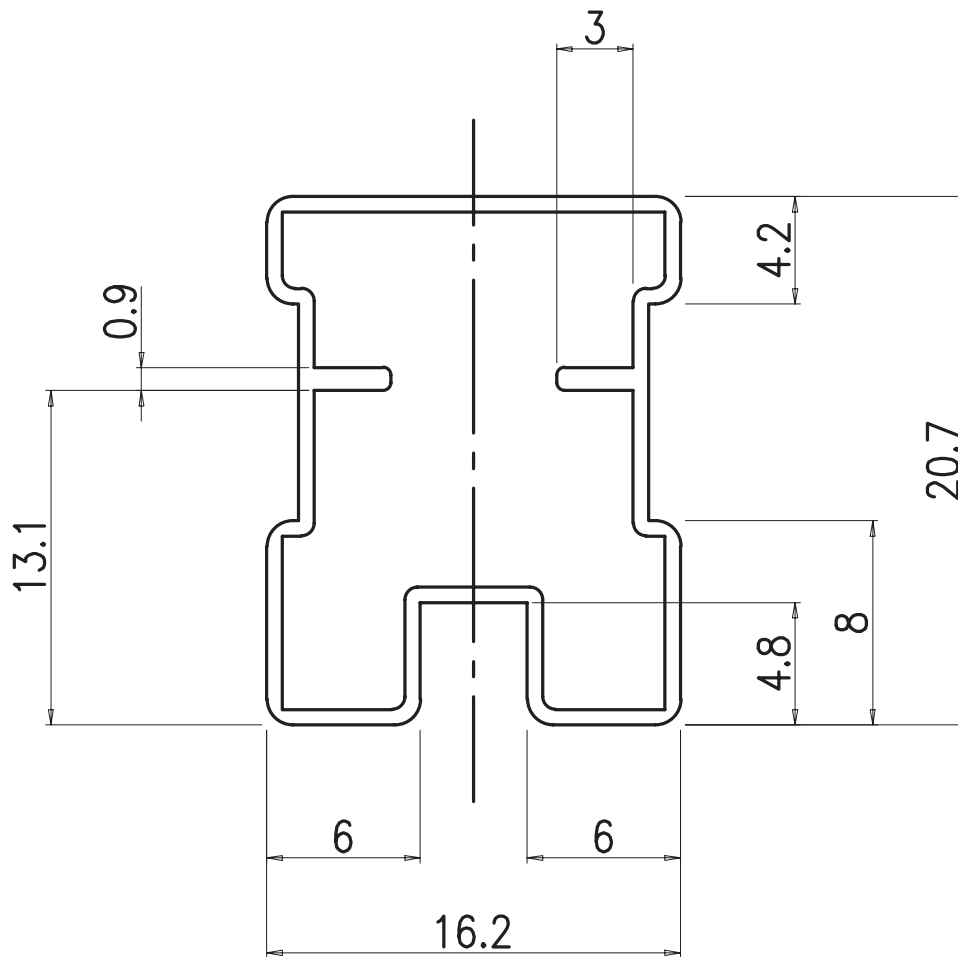

## REVISION HISTORY

rev.	description	date
1.0	initial release	05/30/2023
1.01	CUI Devices rebranded to Same Sky	09/12/2024

The revision history provided is for informational purposes only and is believed to be accurate.



Same Sky offers a one (1) year limited warranty. Complete warranty information is listed on our website.

Same Sky reserves the right to make changes to the product at any time without notice. Information provided by Same Sky is believed to be accurate and reliable. However, no responsibility is assumed by Same Sky for its use, nor for any infringements of patents or other rights of third parties which may result from its use.

Same Sky products are not authorized or warranted for use as critical components in equipment that requires an extremely high level of reliability. A critical component is any component of a life support device or system whose failure to perform can be reasonably expected to cause the failure of the life support device or system, or to affect its safety or effectiveness.

[sameskydevices.com](https://www.sameskydevices.com)