

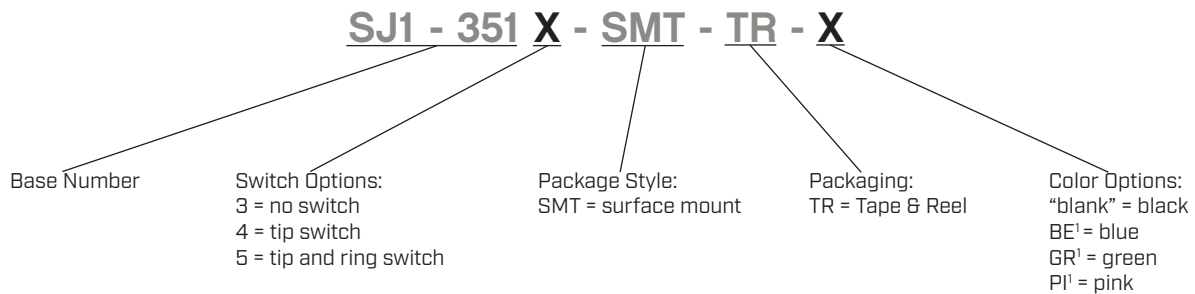

SERIES: SJ1-351X-SMT | **DESCRIPTION:** AUDIO JACK

FEATURES

- low profile design
- switch options include: no switch, tip switch, tip & ring switch
- gold flash
- plastic housing

PART NUMBER KEY

Notes: 1. Tip and ring switch model only

SPECIFICATIONS

parameter	conditions/description	min	typ	max	units
rated input voltage			12		Vdc
rated input current				1	A
contact resistance	between terminal and mating plug between terminal in a closed circuit			50 30	mΩ mΩ
insulation resistance	at 500 Vdc	100			MΩ
voltage withstand	for 1 minute			500	Vac
insertion/withdrawal force		0.3		3	kg
operating temperature		-25		85	°C
life			5,000		cycles
flammability rating	UL94V-0				
RoHS	yes				

MECHANICAL DRAWING

units: mm
 tolerance:
 X.X ±0.30 mm
 X.XX ±0.25 mm
 X.XXX ±0.20 mm
 PCB: ±0.05 mm
 unless otherwise specified

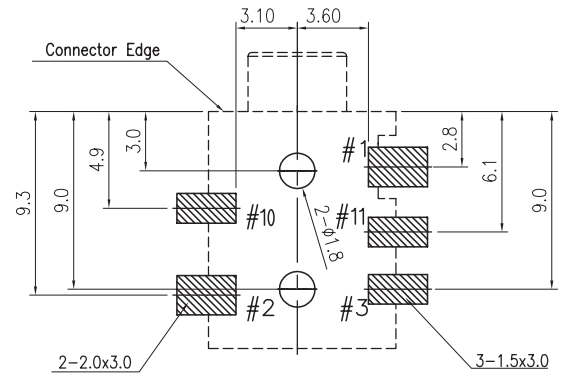
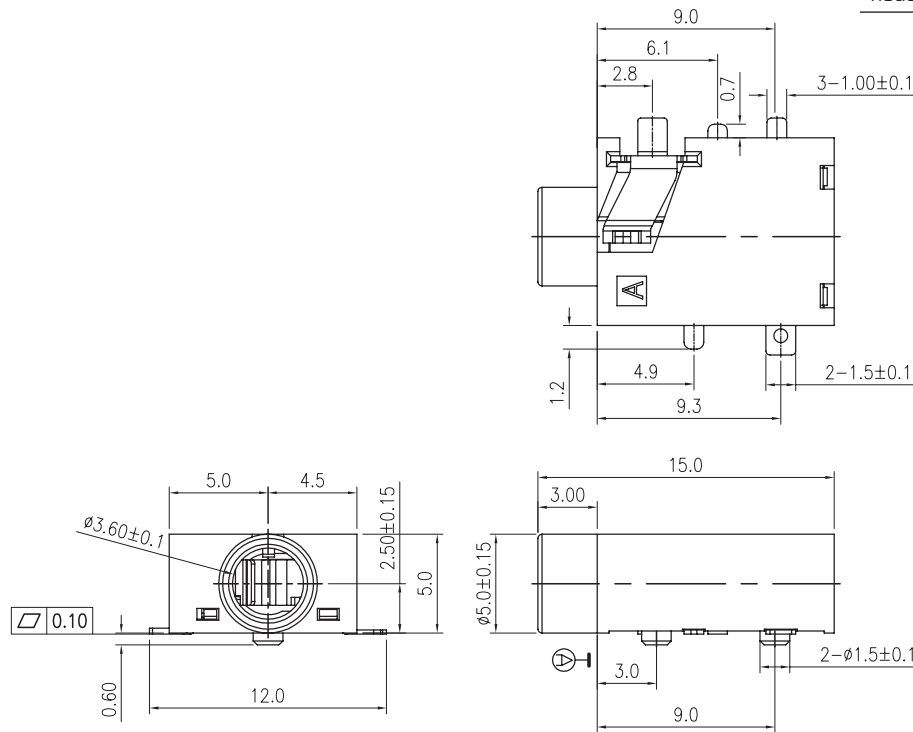
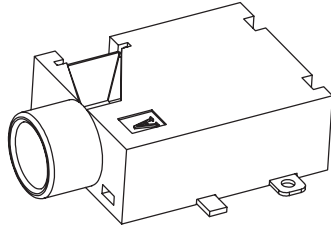

Recommended PCB Layout
Top View

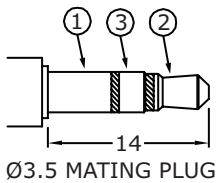

Model No.	SJ1-3513-SMT	SJ1-3514-SMT	SJ1-3515-SMT
Schematic			
PIN			
1	sleeve	sleeve	sleeve
2	tip	tip	tip
3	ring	ring	ring
10	NP	tip switch	tip switch
11	NP	NP	ring switch

DESCRIPTION	MATERIAL	PLATING/COLOR
terminal 1	phosphor bronze t=0.30	gold flash over nickel
terminal 2	phosphor bronze t=0.20	gold flash over nickel
terminal 3	phosphor bronze t=0.20	gold flash over nickel
terminal 10	brass t=0.20	gold flash over nickel
terminal 11	brass t=0.20	gold flash over nickel
cover	PA9T (UL94V-0)	see color options
housing	PA9T (UL94V-0)	see color options

SOLDERABILITY

parameter	conditions/description	min	typ	max	units
reel storage	5~25°C, 20~75% humidity				
reflow soldering	see reflow profile	255	260		°C

Note: 2. Same Sky recommends usage of the product within 24 hours after T&R is opened. After 24 hours, Same Sky recommends drying the parts prior to use.

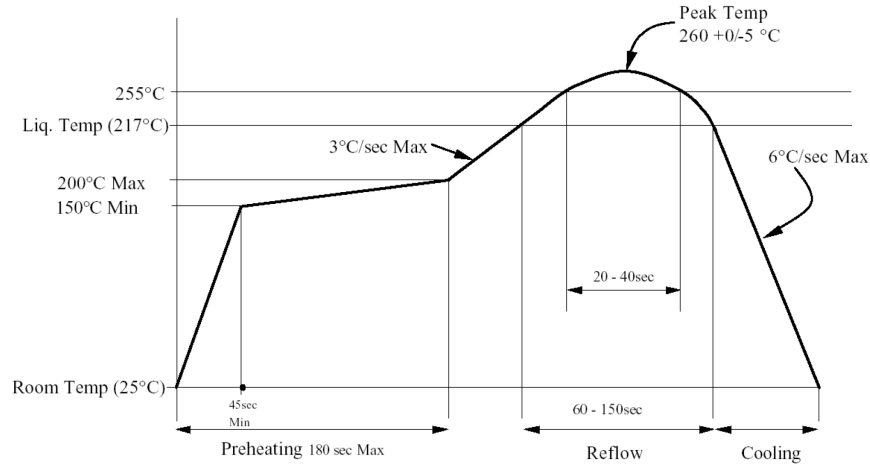

PACKAGING

units: mm

Reel Size: $\varnothing 330$ mm
 Reel QTY: 600 pcs per reel

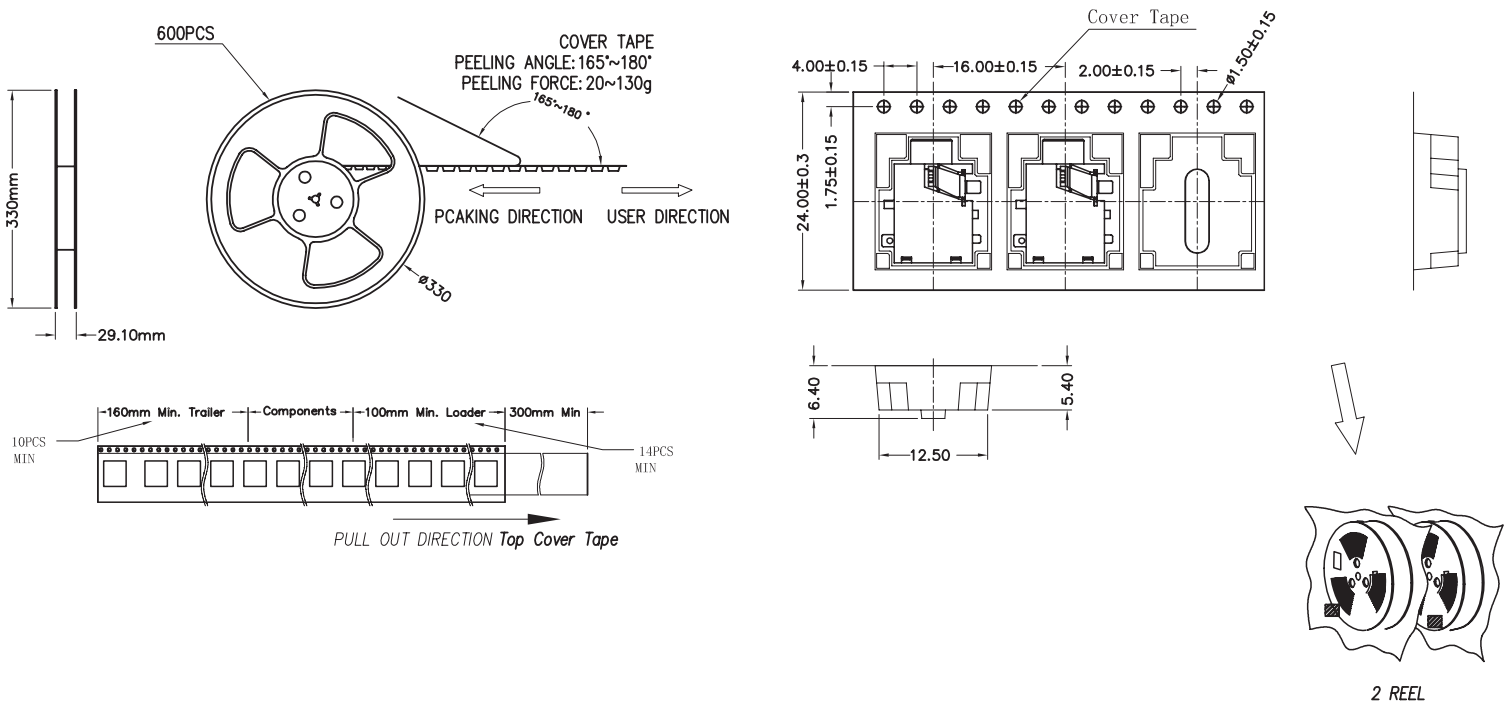

REVISION HISTORY

rev.	description	date
1.0	initial release	11/21/2005
1.01	new template applied	01/27/2012
1.02	added TR package and color options	11/01/2012
1.03	updated datasheet	05/01/2015
1.04	added model, updated datasheet	12/19/2016
1.05	added storage and drying conditions	02/15/2018
1.06	brand update	10/09/2019
1.07	discontinued model SJ1-3513C-SMT-TR; logo, datasheet style update	08/17/2022
1.08	product reengineered for improved manufacturability and production yield, see PCN for details	03/08/2023
1.09	CUI Devices rebranded to Same Sky	09/12/2024

The revision history provided is for informational purposes only and is believed to be accurate.



Same Sky offers a one (1) year limited warranty. Complete warranty information is listed on our website.

Same Sky reserves the right to make changes to the product at any time without notice. Information provided by Same Sky is believed to be accurate and reliable. However, no responsibility is assumed by Same Sky for its use, nor for any infringements of patents or other rights of third parties which may result from its use.

Same Sky products are not authorized or warranted for use as critical components in equipment that requires an extremely high level of reliability. A critical component is any component of a life support device or system whose failure to perform can be reasonably expected to cause the failure of the life support device or system, or to affect its safety or effectiveness.

[sameskydevices.com](https://www.sameskydevices.com)