



MODEL: SPK-015A | **DESCRIPTION:** KNOB

FEATURES

- plastic
- D-cut shaft compatible



MECHANICAL DRAWING

units: mm
 tolerance:
 $X \leq 5.00$: ± 0.12 mm
 $5.00 < X \leq 10.00$: ± 0.14 mm
 $10.00 < X \leq 20.00$: ± 0.18 mm
 $20.00 < X \leq 30.00$: ± 0.24 mm
 unless otherwise noted

DESCRIPTION	MATERIAL	PLATING/COLOR
outer housing	TPE (UL94V-2)	black
inner housing	ABS (UL94V-2)	white

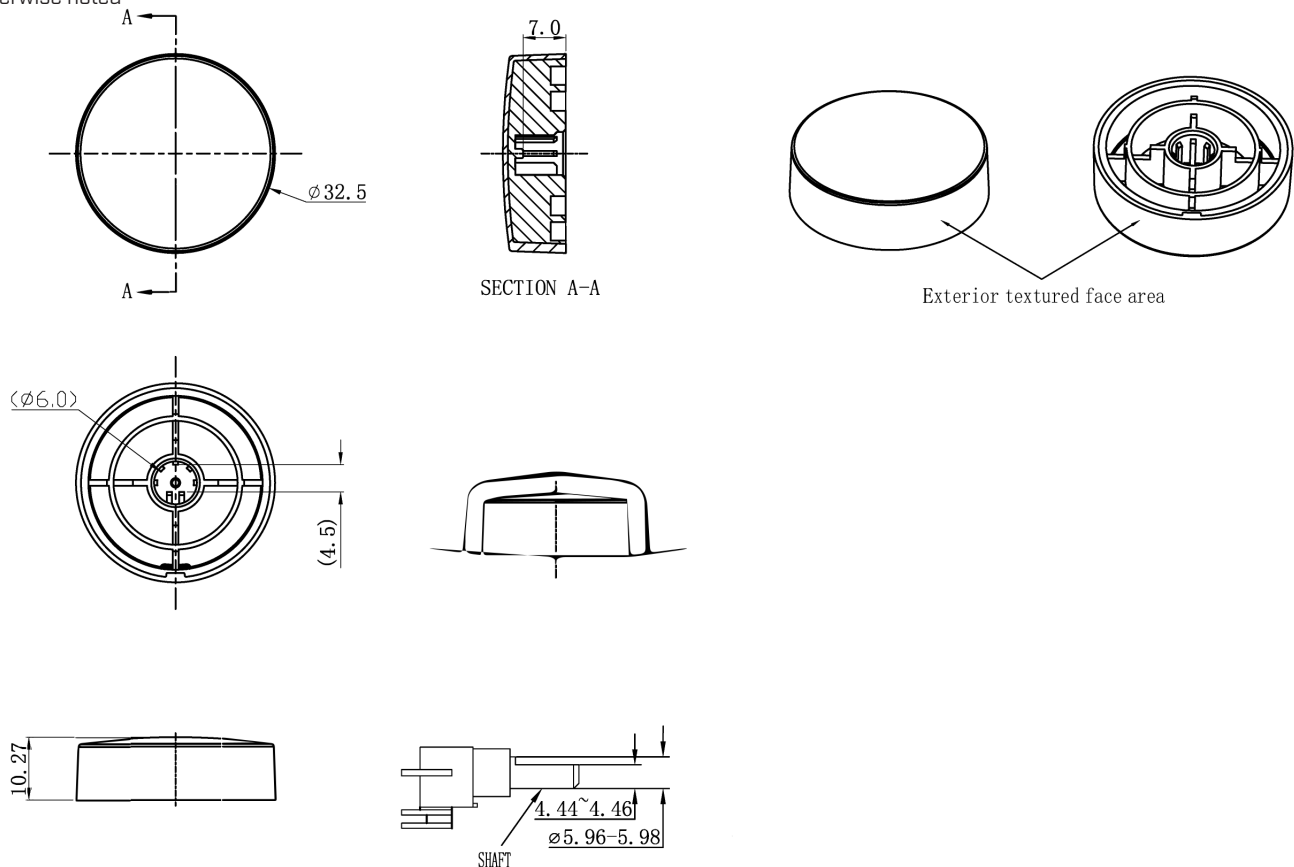

Compatible Shaft Size
 Withdrawal Force: 1.5~7.5 kg

REVISION HISTORY

rev.	description	date
1.0	initial release	01/15/2025

The revision history provided is for informational purposes only and is believed to be accurate.



Same Sky offers a one (1) year limited warranty. Complete warranty information is listed on our website.

Same Sky reserves the right to make changes to the product at any time without notice. Information provided by Same Sky is believed to be accurate and reliable. However, no responsibility is assumed by Same Sky for its use, nor for any infringements of patents or other rights of third parties which may result from its use.

Same Sky products are not authorized or warranted for use as critical components in equipment that requires an extremely high level of reliability. A critical component is any component of a life support device or system whose failure to perform can be reasonably expected to cause the failure of the life support device or system, or to affect its safety or effectiveness.

[sameskydevices.com](https://www.sameskydevices.com)