

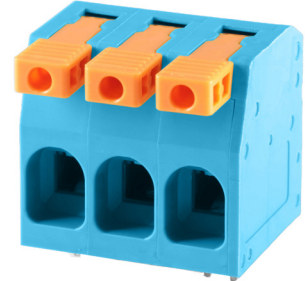

SERIES: TBL-0016-1000 | **DESCRIPTION:** TERMINAL BLOCK

FEATURES

- 1-6 poles
- 10.00 mm pitch
- blue, green, red, white, & yellow options
- UL safety approval



SPECIFICATIONS

parameter	conditions/description	min	typ	max	units
rated voltage (UL)	Use Group: B (1P/XP models)			300/600	V
	C (1P/XP models)			150/600	V
	D (1P/XP models)			300/-	V
rated current (UL)	Use Group: B (1P/XP models)			51/51	A
	C (1P/XP models)			51/51	A
	D (1P/XP models)			10/-	A
rated voltage (IEC)	Overvoltage Category/Pollution Degree: III/3 (1P/XP models)			400/1,000	V
	III/2 (1P/XP models)			400/1,000	V
	II/2 (1P/XP models)			800/1,000	V
rated current (IEC)	Overvoltage Category/Pollution Degree: III/3 (1P/XP models)			76/76	A
	III/2 (1P/XP models)			76/76	A
	II/2 (1P/XP models)			76/76	A
withstanding voltage	for 1 minute (1 pole model)		1,600		Vac
	for 1 minute (all other pole models)		2,200		Vac
surge voltage	1 pole model			4,000	V
	all other pole models			8,000	V
contact resistance				20	mΩ
insulation resistance	at 500 Vdc	500			MΩ
operating temperature		-40		105	°C
safety approvals	UL 1059 certified, IEC 60947-7-4 compliant				
flammability rating	UL94V-0				
wave soldering	for maximum 5 seconds		260		°C
RoHS	yes				

PART NUMBER KEY

TBL - 0016 - 1000 - XX XX - 2OR

Base Number

No. of Poles:
01 03 05
02 04 06

Body Color:
BE = blue WT = white
GR = green YL = yellow
RD = red

MECHANICAL DRAWING

units: mm
 tolerance:
 $X \leq 6.00$: ± 0.20 mm
 $6.00 < X \leq 10.00$: ± 0.30 mm
 $10.00 < X \leq 30.00$: ± 0.50 mm
 $30.00 < X \leq 60.00$: ± 0.70 mm
 $60.00 < X \leq 100.00$: ± 1.00 mm
 $100.00 < X \leq 160.00$: ± 1.30 mm
 $X > 160.00$: ± 1.60 mm
 unless otherwise noted

DESCRIPTION	MATERIAL	PLATING/COLOR
housing	PA66 [UL94V-0]	
lever	PA66 [UL94V-0]	orange
contacts	copper alloy	tin

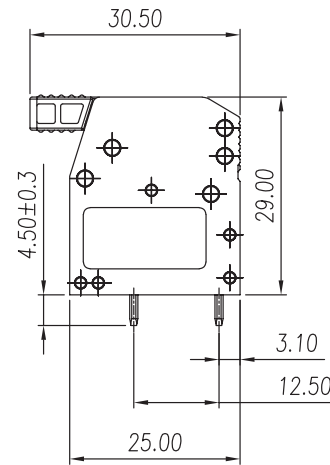
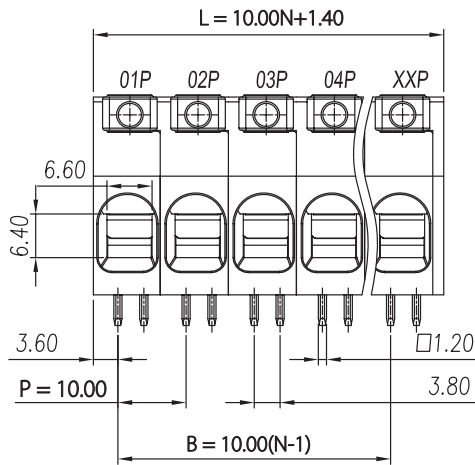
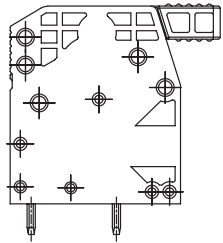
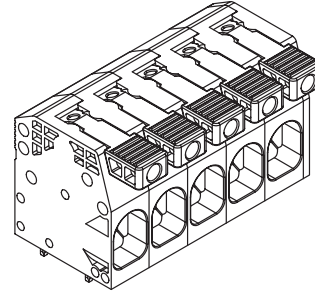
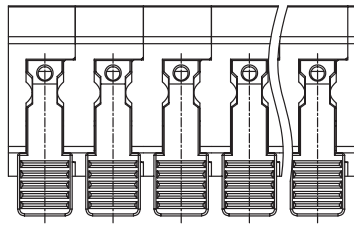

1 pole module only

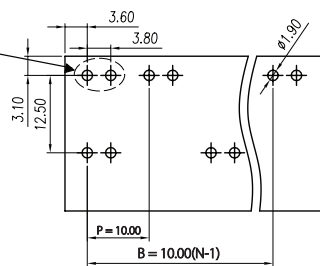

Recommended PCB Layout
Top View

WIRE ASSEMBLY		
	UL	IEC
Wire Range	18~4 AWG	0.2~16 mm ²
Strip Length	18 mm	

This series is constructed of 1 pole modules where L is the total length, P is the pitch, and N is the number of poles.

N	01	02	03	04	05	06
L	11.40	21.40	31.40	41.40	51.40	61.40
B	-	10.00	20.00	30.00	40.00	50.00

REVISION HISTORY

rev.	description	date
1.0	initial release	03/18/2024
1.01	CUI Devices rebranded to Same Sky	09/12/2024

The revision history provided is for informational purposes only and is believed to be accurate.



Same Sky offers a one (1) year limited warranty. Complete warranty information is listed on our website.

Same Sky reserves the right to make changes to the product at any time without notice. Information provided by Same Sky is believed to be accurate and reliable. However, no responsibility is assumed by Same Sky for its use, nor for any infringements of patents or other rights of third parties which may result from its use.

Same Sky products are not authorized or warranted for use as critical components in equipment that requires an extremely high level of reliability. A critical component is any component of a life support device or system whose failure to perform can be reasonably expected to cause the failure of the life support device or system, or to affect its safety or effectiveness.

[sameskydevices.com](https://www.sameskydevices.com)